

Digital Audio Matrix Processor

User Manual



Thank you very much for purchasing our products. In order to ensure the best performance of the products,



please read the user manual carefully before using!

Contents

Thank you for choosing our products, please read the manual before using!

1. This manual provides information about all models of the same series. Due to different model configurations, the actual configuration of the products you choose may be different from the instructions in this manual. Please refer to the products you actually purchase.
2. This manual only for the user's operation instructions.
3. This manual is the copyright of our company. Without permission, do not allow to use part or all of this manual for commercial purposes.

Caution

1. Turn off the power before installing, removing and wiring the equipment.
Otherwise, there will be a risk of electric shock.
2. Do not disassemble the machine, otherwise it will cause failure
3. Please use the unit within the following conditions (temperature, humidity, vibration, installation direction, environment, etc.) Otherwise, there is a risk of fire or malfunction.
4. Do not block the ventilation holes of the equipment. Otherwise, there is a risk of fire or malfunction.
5. Please follow the standard of the machine connection, the specified power supply and construction method, and wire it correctly. Otherwise, there is a risk of electric shock, fire, or malfunction.
6. Do not let the broken wire, iron power, water inside the case. Otherwise, there will be a risk of fire.
7. When disposing of the machine, please follow the local regulations, Properly handled according to industrial waste. ♻️
8. The equipment must be exposed to water droplets or water splashes.
9. The equipment should be connected to the grid power outlet with protective grounding.
10. If the power plug and appliance coupler are used as disconnect devices, the disconnect device should be kept easy to operate (Such as knife switch or leakage switch)
11. The equipment is only suitable for safe use in areas below with an elevation of 2000 meters. 
12. The equipment is only suitable for safe use in non-climate conditions. 



Content

1. Intruction	8
1.1 Product Appearance.....	6
1.2 Function Instruction	6
1.3 Technical Specifications	7
2. Equipment structure.....	8
2.1 Equipment front panel description	8
2.2 Equipment rear panel description	8
3. Software Structure.....	10
3.1 Open workspace	10
3.1.1 Workspace Instruction	11
3.1.2 Device	12
3.1.3 Local scene	12
3.2 Overview of workspace interface	13
3.3 Menu.....	13
3.3.1 “File” Menu	13
3.3.2 “Help” Menu.....	14
3.4 Device list area.....	15
3.4.2 Login.....	17
3.4.3 Exit.....	17
3.4.4 Device list area right-click menu	17
3.4.9 Upgrade	19
Select “upgrade...” menu item in the right-click menu of the device list area, the upgrade dialog box will pop up as shown below.	19
3.4.10 Full.....	20
3.4.11 Toggle	20
3.5 Local scene list area.....	20
3.5.1 Local scene list area right-menu	22
3.5.2 New scene	23
3.5.3 Modify scene	23
3.5.4 Remove the selected scene.....	23
3.5.5 Delete the selected scene.....	23
3.5.6 Open scene	23
3.5.8 Save as scene	24
3.5.9 Full select.....	24
3.5.10 Toggle	24
3.6 Status.....	24
4. Workspace interface control area.....	25
4.1 Audio Ports	25

4.1.1 Input port:.....	26
4.1.2 “Port mute”、 “Group mute” and “All mute”	28
4.1.3 Output port.....	28
4.1.4 Group.....	30
4.2 Audio channel.....	30
4.3 Scene management	30
4.4 GPIO	32
4.4.1 Scene	35
4.4.2 Mix	36
4.4.3 Increase volume	37
4.4.4 Level	38
4.4.6 All mute	40
4.4.7 Send serial port command	41
4.5 Central control	41
4.6 Network settings	44
4.8 User management	47
5.1 Input	50
5.2 Extension	52
5.3 Equalizer	53
5.4 Compression	55
5.5 Automatic gain.....	56
5.6 Automatic mixing.....	57
5.7 Feedback/Echo cancellation	60
5.8 Noise suppression	61
5.9 Mixer	62
5.10 Frequency division.....	65
5.11 Delay.....	66
5.12 Output.....	67
5.13 Limit	68
6. FAQ	69

1. Instructions

1.1 Product Appearance



1.2 Function Instruction

This device supports 16 input 16 output analog channels, USB extended recording and broadcasting channel. It has built-in feedback/echoic cancellation, noise suppression and other algorithms, and supports multiple scenes. The interface can manage multiple equipment at the same time, which is suitable for conference room, classroom, court and other small and medium-sized non-public broadcasting on-site amplification and recording and other application requirements. Its operation is simple and the performance is powerful:

- 1、 Full matrix mixer function ,24 bit/48KHz sampling frequency, high performance A/D, D/A converter and 32- bit floating point DSP processor.
- 2、 Efficient algorithm processing: input port processing has signal generator, gain regulation, extender, compressor, equalizer, packet control, etc.; Output processing has frequency divider, equalizer, delay, gain regulation, amplitude limiter, packet control, etc.; there are automatic mixing (AM), automatic gain (AGC), feedback suppression (AFC), echo cancellation (AEC), automatic noise reduction (ANS) 5A core algorithm.
- 3、 Rich interface extensions: support 8-channel custom input and output GPIO control interface, level support external input 3.3 V;USB interface support recording and broadcasting function; RS232、 RS485 control interface. .
- 4、 Support a variety of scene presupposition, scene preservation and other functions, humanized operation software interface.
- 5、 User software supports Windows platform clients.

1.3 Technical Specifications

Input processing	Signal generation, gain regulation, expansion, equalization, compression, automatic gain, automatic mixing, feedback/echoic cancellation, noise suppression, packet control
Output procession	Frequency decision, EQ, delay, Gain, Limiting, Grouping control
RS232 interface	1
RS485 interface	1
LAN netting	1
USB recording and broadcasting interface	1
Input impedance	Balance input 20K Ω
Maximum output level	18dBu
Microphone sensitivity	0dBu, -6dBu, -12dBu, -18dBu, -24dBu, -32dBu, -36dBu, -42dBu
Output impedance	Output balance 40 Ω
Output impedance level	18dBu
Frequency Response	$\pm 0.5\text{dB}@20\text{Hz}-20\text{KHz}$
THD	0.003% @ 1KHZ 6dBu
Bottom noise	<-87dBu
EQ	Input: 5, Output: 8
Output delay	0-2000ms, Increment 100us
High-Shelf equilibrium frequency range	20Hz-20KHz
High-Shelf equilibrium range	+/-15dB, Increment 0.1dB
Low-Shelf equilibrium frequency range	20Hz-20KHz
Low-Shelf equilibrium range	+/-15dB, Increment 0.1dB
Types of high pass filters	Butter worth, Bessel, Linkwitz -Riley
High pass filter slope	6, 12, 18, 24, 32, 36, 42, 48(dB/Octave)
High pass filter range	20Hz-20KHz
Types of high pass filters	Butter worth, Bessel, Linkwitz-Riley
Low-pass filter slope	6, 12, 18, 24, 32, 36, 42, 48(dB/Octave)
Low-pass filter range	20Hz-20KHz
Compression threshold	0dB -72dB, Increment 0.1dB
Compression ratio	1-20
Compression time	5-1000m
Compression recovery time	5-1000m
Compression Gain Compensation	-24dB~30dB
Input A/D conversion	24bit
Output D/A conversion	24bit
Sampling rate	48KHz
Power supply	100-240V AC@50/60Hz 30W
Connector	Phoenix socket
N. W	2.55KG (8 input 8 output) 、 2.7KG (16 input 16 output)
G. W	3.4KG (8 input 8 output) 、 3.55KG (16 input 16 output)
Size(Length *Width *Height)	483mmX210mmX45mm

2. Equipment structure

2.1 Equipment front panel description

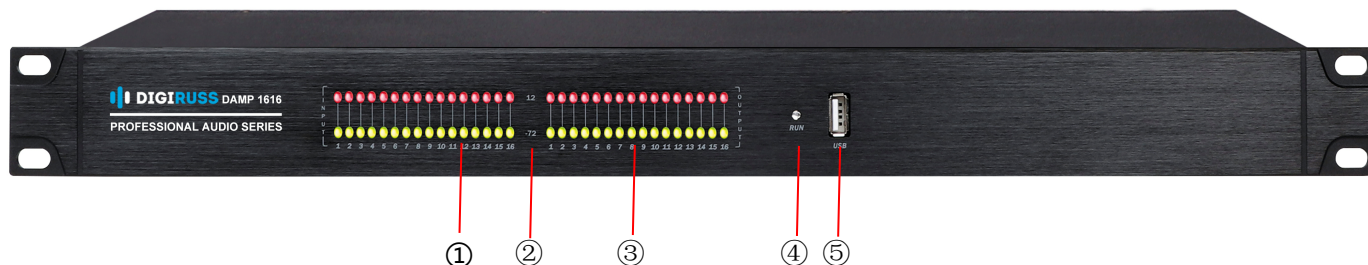

- ① Input: Input level indicator
- ② -72/12: Level value display
- ③ Output: Output level indicator
- ④ Run: Equipment status indicator (Green light indicates that the system is running normally)
- ⑤ USB: Support video recording function

2.2 Equipment rear panel description

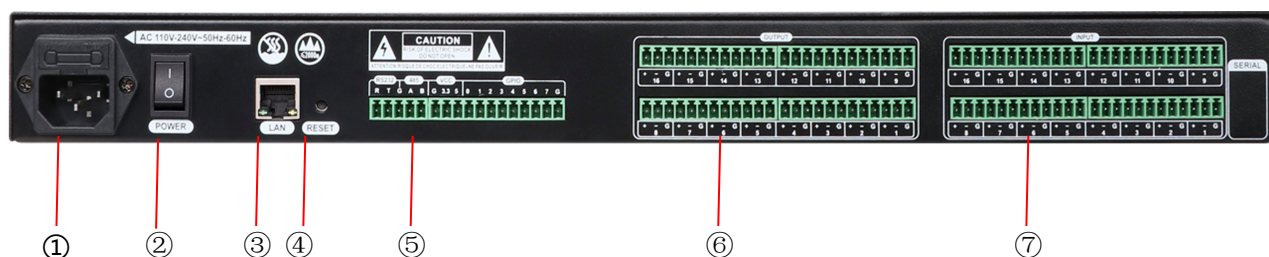

- ① Power socket: Support AC 100V ~ 240V power supply, 50 ~ 60Hz
- ② Power: Power switch
- ③ Lan: Ethernet interface for connection control (PC, Routers.)
- ④ RESET: Restore factory configuration button. If the button is continuously pressed while the device is powered on, until the screen is connected. When the light flashes, the device will be restored to the factory configuration and automatically restarted. IP address, registration of equipment, hire name and password, scene will be restored to factory configuration.
- ⑤ RS232: Communication port, the central control device can use the serial port to control the device;
RS485: Communication port, external wall-type touch control screen, to achieve third-party equipment control of the device.
VCC: 5V and 3.3V power supply
GPIO: the specific connection mode refers to section 4.4 for GPIO setting
- ⑥ Input: Analog audio input interface with up to 16 input ports.
- ⑦ OUTPUT: Analog audio output interface with up to 16 input ports.

Factory configuration of equipment

Factory Configuration	Factory Configuration Value
IP address	IP Address: 192.168.20.20 Subnet Mask: 255.255.255.0 Gateway: 192.168.20.1
Login user name/Password/ Group name	1.admin/admin/admin 2. user/user/user The user belong to admin group has user management. The user belong to user group do not has user management.
Scene	Different device models have different factory configuration scenarios

3. Software Structure

The software supports Windows Vista、Windows XP、Windows 7、Windows 8 and Windows 10 operating system.

Using the interface installation package to install the interface program. Once installed successfully, take the Windows 7 as an example , click the “Start/All Programs/AudioProcessor/AudioProcessor” menu item or double-clicking the “AudioProcessor” icon on the desktop to run the interface program.

3.1 Open workspace

When runs the program, it will automatically open the workspace used by the program during last exit. For example, if the workspace setting has a password, it will dialog bow pop up as show in Figure3-1, asking the user to enter the password for the workspace.

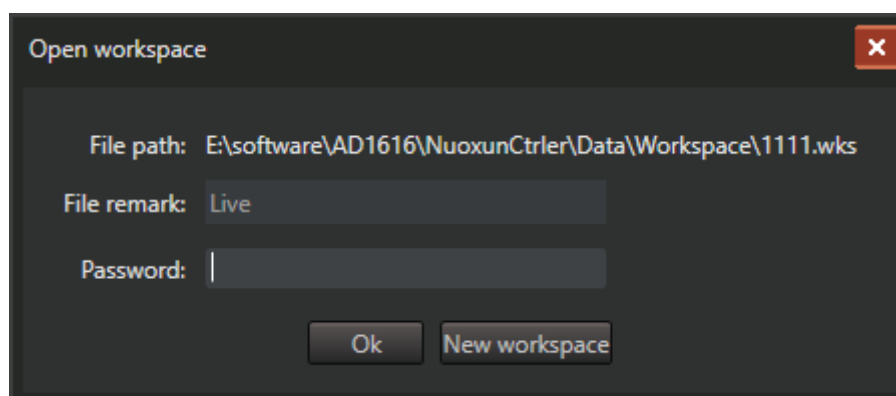

Figure 3-1 “Open workspace” interface

“The file path”

Shows the path of the open workspace file in the computer file system.

“File description”

Shown the workspace description.

“Password”

User needs to enter the correct password for the open workspace to open the workspace.

“OK”

After click this button, if the password is correct then user can enter the workspace. Otherwise, the password error message box will pop up.

“New workspace”

Creating a new blank workspace into the interface, as shown in Figure 3-2.

In the new workspace, user can search device, add device, login device. See section 3.4 for detail.

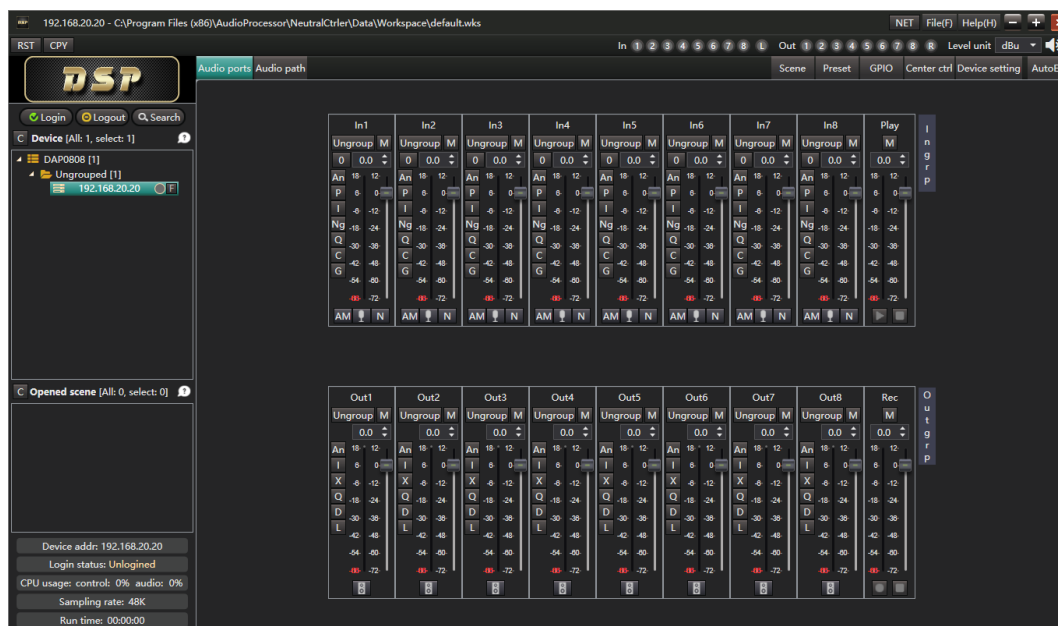

Figure 3-2 “New workspace “interface

After enter the new workspace interface, user can open the other workspace again. See section 3.3.1 for detail.

It won't pop up the dialog box to ask enter the password and directly to the interface of workspace, if the workspace does not set the password.

If the interface program is running for the first time, or the workspace has been deleted last exit. Then the interface program goes directly to the new workspace, as shown in Figure 3-2.

3.1.1 Workspace Instruction

The workspace interface program uses workspace to record the device and local scene by user. The workspace is saved in the suffix names. (short for workspace) in a file. The workspace includes device list and local scene list. The device list contains the device information, including the device's local alias, local model, IP address, login user name and password, etc. Local scene list contains local scene information, including the local file name, device model, scene description, etc. Workspace allows users to easily view, manage multiple devices and edit multiple scene off line at the same time, also allow multiple devices log in, exit and upgrade together, allow copy and paste parameters

between multiple devices, devices and local scene.

The log-in user name and password of each device are recorded in the workspace to avoid entering the password each time the device is logged in. For security reasons, user also can set passwords to the workspace avoid unauthorized user manipulation devices in the workspace. If the workspace has a password set, user need to enter the correct password when open the workspace. The user also can lock the workspace when leaving temporarily. See section 3.3.1 for detail.

3.1.2 Device

The device records the device's IP address, login user name, password information, etc. And will record the latest parameters of the device.

Even if the device is not logged in, change the parameter of the device on the interface, the parameters also can be saved in the local device file. When opened the workspace next time, the latest parameters of the device will be displayed. Local device parameters are not synchronized to the actual device when the device is not logged in.

After the device login is successful, the parameters in the actual device will automatically synchronize to the interface, overwrite the local device parameters recorded in the interface. If you want to save the latest local parameters of the device and don't want to overridden by the parameters int the device when logging on the device. You can save the device parameters to the local scene by" Saving as scene" (See section 3.4.7 for detail).

3.1.3 Local scene

Local scene is used to save the parameters in the audio channel of a certain of device, the local scene is saved in the suffix name. scn in the local scenario file. After setting the parameters in the local scene on the interface, you can upload the local scene file to the local scene to the device of the corresponding model and play a role by loading the scene. You also can download scenes on your device to your computer to be local scene. Through the download and upload of the local scene, the scene synchronization between different devices can be realized.

Device parameters can also be saved as local scenarios by "Save as scene". See section 3.4.7 for detail.

3.2 Overview of workspace interface

The workspace interface is shown as follow figure 3-3.

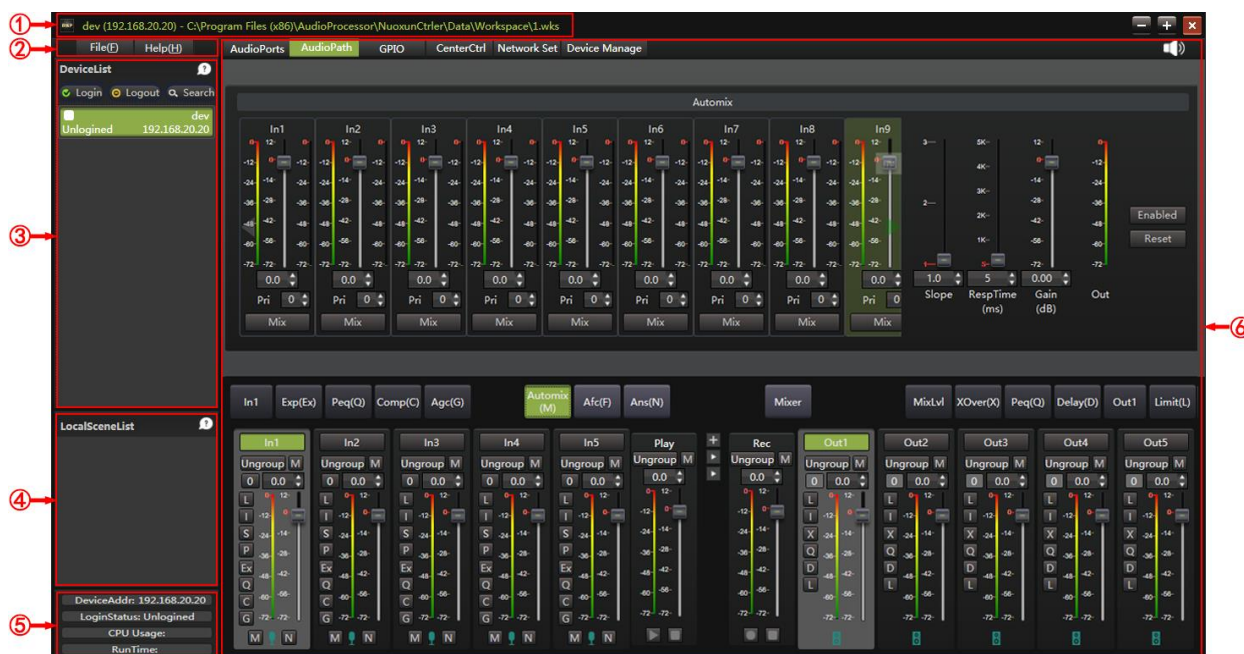

Figure 3-3 Workspace interface

(1) Title bar: Displays the local alias of the current device, the IP address (or current local scene file path) and workspace file path.

(2) Menu bar: Menu bar has "file" and "help" menu. See section 3.3 for detail.

(3) Device list: User can add device, delete device and toggle current device, manage multiple devices simultaneously.

(4) The local scene list area: User can add or delete local scene for off line scene.

(5) Status bar: Display the current device's IP address, login status, CPU usage, etc.

(6) Control area: Control current device or local scene's parameters.

The follow section of this chapter describes the menu bar, device list, local scene and status bar. Chapter 4 will describe the control area.

3.3 Menu

Menu bar has "File" and "help" menus. The "File" menu contains items related to the workspace; "Help" menu has "Help document", "language" and "About" menu items.

3.3.1 "File" Menu

The "File" menu shown as following figure 3-4.

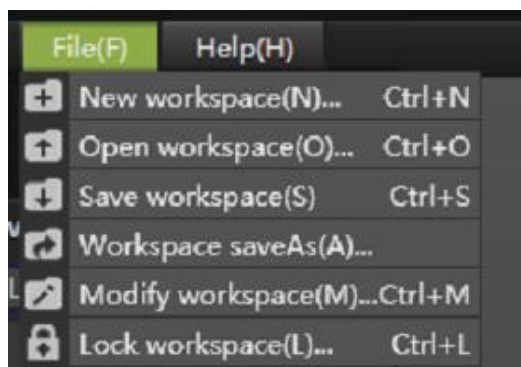

Figure 3-4 “File” Menu

“New workspace”: Create an empty workspace, as shown in Figure 3-2.

Both “Device list” and “Local scene list” are empty. Shortcut key is “Ctrl+N”. See section 3.1 for details.

“Open workspace”: Open an existing workspace in computer file system (.wks document). Shortcut key is “Ctrl+O”. See section 3.1 for details.

“Save workspace”: Save workspace manually, shortcut key is “Ctrl+S”. Workspace will automatically save when it is closed. Manually save up-to-date information that can avoid losing workspace due to program exception exit

“Workspace save as”: Save the workspace to another file.

“Modify workspace”: Modify the workspace's file description and password., shortcut key is “Ctrl+M”.

“Lock workspace”: When a user leaves the computer temporarily, it can lock the workspace to prevent unauthorized operations. After the workspace is locked, the correct workspace password must be entered to unlock. Shortcut key is “Ctrl+L”.

3.3.2 “Help” Menu

“Help” menu shown as following figure 3-5.

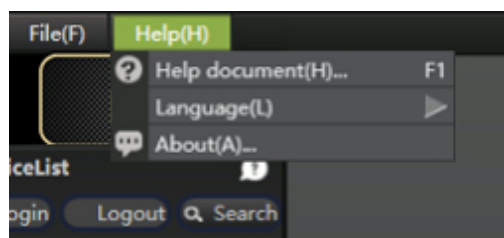

Figure 3-5 “Help” menu

“Help document”: Open the help document. Shortcut key is F1.

“Language”: The interface text is switched between languages, currently supported in simplified Chinese and English.

“About”: Display the version of the interface program, copyright and other

information.

3.4 Device list area

Device list area display devices allow to add. User can add, delete, log in, exit, upgrade and select the current device. The equipment list area is shown as below.

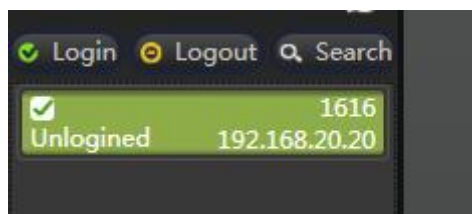

Figure 3-6 Device list area

Device items

Multiple devices items are display simultaneously in the device list. Each device item consists of a check box, local alias, device login status, and IP address (Shown serial port name when serial port is connected). Hover the mouse over the device item and the device model will be displayed.

The check box is designed to operate multiple devices simultaneously. Login, exit, delete, and upgrade operations can be performed simultaneously for one or more selected devices.

Check device

The check box is ticked for the device. In the list of devices shown in Figure 3-6, the second device is ticked. Check the number of devices can be 0,1 or more.

Current device

The device selected in the device list; the background of the current device will be highlighted. In the list of devices shown in Figure 3-6, the first device is the current device. The current device can be 0 or 1.

If the current device exists in the device list, the parameters of the current device will be displayed in the control area, and its status will be displayed in the status bar.

Selected device

If one or more tick devices exist in the device list, the device is selected for these tick devices, and if tick devices do not exist in the device list, the device is selected as the current device.

Login, exit, delete, and upgrade operations are valid for selected devices.

Help information

Click the help button on the right side of the device list area title, then will display the help information, as shown in the figure below.

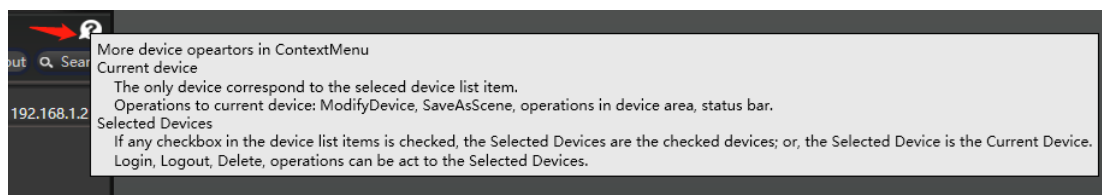

Figure 3-7 Device list area help information

The following is a description of the common operations in the equipment list area

3.4.1 Search

“Search “can search for all devices present in this LAN. Click the search button in the device list area and will pop up search device dialog as shown Figure 3-8. The first time you open the search device dialog bow, you will search for all devices exist in this LAN automatically and present them to the list. Every time you click the Refresh button, you re-search all the devices that exist in the current LAN and render them to the list.Each device searched will display "device name ", " IP address" and "device model ". the user can select the device to add by ticking the check box in the" select "column, or by clicking the" select "and" Toggle "buttons to select all or reverse select the device to be added. Click the Add button to add all checked devices to the device list.

All devices within this LAN can be searched even if their I P address is not in the same subnet as the computer running the interface program. when the I P address of the searched device is not in the same subnet as the computer, it is necessary to add a I P address to the computer that belongs to the same subnet as the device to log on to the device correctly. See section 3.4.2 for details.

A device that is not within this domain network will not be searched and will need to be added manually by filling in its IP address. See section 3.4.5 for details.

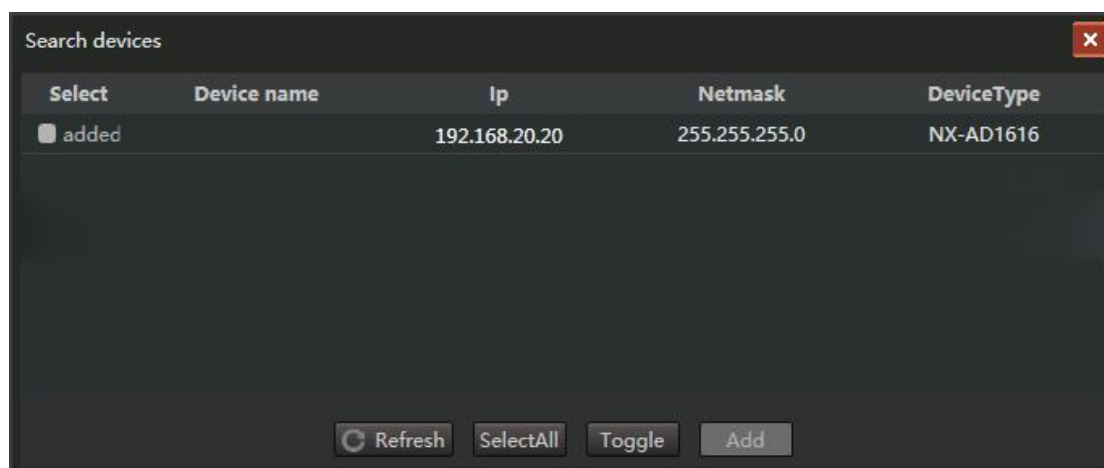

Figure 3-8 Search device dialog box

3.4.2 Login

Clicks the "login" button in the device list area, all selected devices will be logged in at the same time. If a selected device failed to log in, an error message box will pop up listing the reasons for the device failed.

The default IP address of device factory setting is "192.168.20.20" (the address is searchable, See section 3.4.1). If you want to log in correctly, You need to connect your computer to the same LAN on the device, and manually add a IP address belonging to the subnet for the computer's network port. For example, If the computer IP address is "192.168.20.15", the subnet mask is "255.255.255.0", the gateway address can be set to "192.168.20.1". For the method of adding IP addresses to your computer, see the answer to question 1 in chapter 6.

When the login device is successful, you can modify the IP address of the device to other IP. according to the network connection if necessary, See section 4.6.1 for details.

3.4.3 Exit

Click the exit button in the device list area, all selected devices will be withdrawn at the same time.

3.4.4 Device list area right-click menu

Right-click the device list area and will show the menu as below.

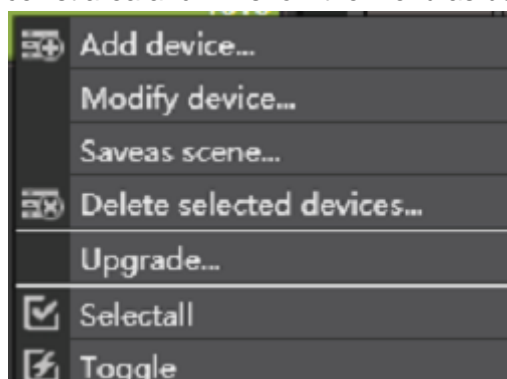

Figure 3-9 Right-click menu for the device list

The following sections illustrate the menu items in the right-click menu

3.4.5 Add device

Add device in the device list area right-click menu select "add device." menu item, the add device dialog box will be opened as shown below figure.

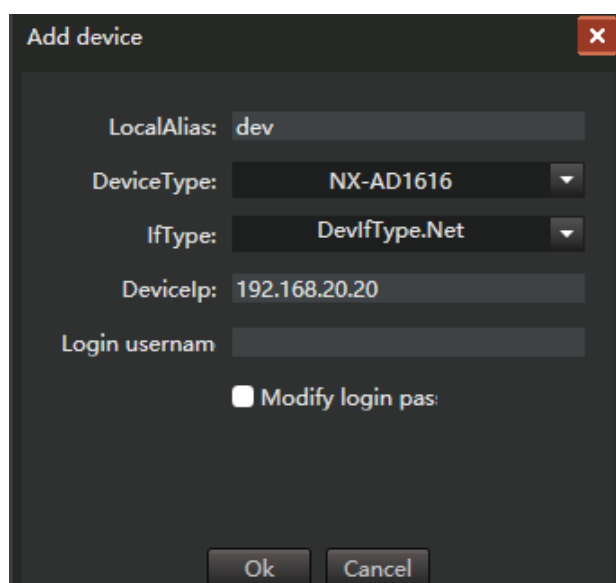

Figure 3-10 Add device dialog bow(Interface type is Newport)

You can select "Device Model" for the added device and "Interface Type" for the connection device. You can fill in the "local alias" of the device to distinguish between different devices. Interface types are "network port" and "serial port ", the computer and equipment usually use network port connection. At this time, you need to fill in the correct "device address ", " login user name" for the device, check "modify the login password ", you can set the login password for the login user name. Click the OK button to add the device to the device list.

If the computer is connected with the device through a serial port, you need to set the interface type in Figure 3-10 to "serial port ", as shown in the figure below. Need to select the "serial port" used to connect the device in the "serial port" drop-down box, click "OK" to add the device to the device list. If the serial port used by the connection device does not appear in the list of the drop-down box, you can click the "refresh serial port" button to let the program list all the serial ports of the computer.

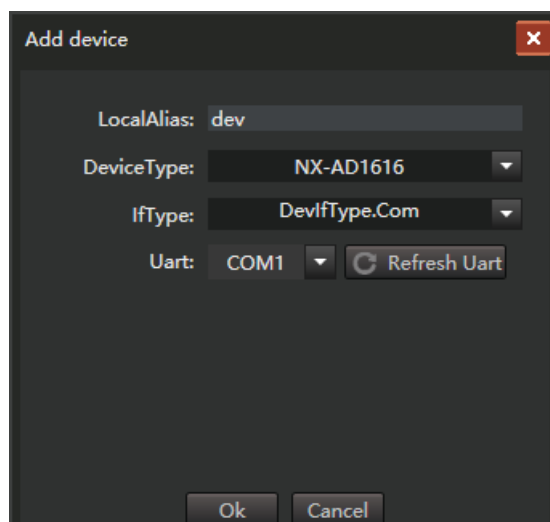

Figure 3-11 Add device dialog box (Interface type is serial port)

When you add devices, the IP address (Interface type is net port) or the serial port (Interface type is serial port) cannot be same as the existing device in the device list. Otherwise, add operation will fail. That is, the same device usually appears only once in the device list.

After adding the device, the control area displays the default parameters of the selected device model. When the device is logged in successfully, if the actual physical device model is not consistent with the added device model, the device model on the interface will automatically change to the device model of the actual physical device, and the device parameters displayed on the interface will automatically synchronize to the parameters of the actual physical device.

3.4.6 Modification of device

Select “modify device...” menu item in the right-click menu of device list area, the modify device dialog box will pop up. The “Modify Device” dialog box is the same as the “Add Device” dialog box, where all properties of the current device can be modified. If the current device has been logged in, other information other than "Local alias" will not be modified. after exiting the login, all information of the device can be modified. Double-click the left mouse button on the current device to quickly open the Modify Device dialog box.

3.4.7 Save

Right-click menu select “Save as a scene “menu item, you can save the parameters in the current device “AudioPath” as a local scene file and add to the local scene list. the description of the local scenario is detailed in section 3.5.

3.4.8 Delete selected device

Select the “delete select device...” menu item in the right-click menu of the device list area, you can remove all selected devices from the device list.

3.4.9 Upgrade

Select “upgrade...”. menu item in the right-click menu of the device list area, the upgrade dialog box will pop up as shown below.

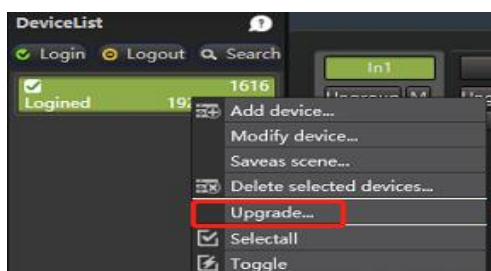

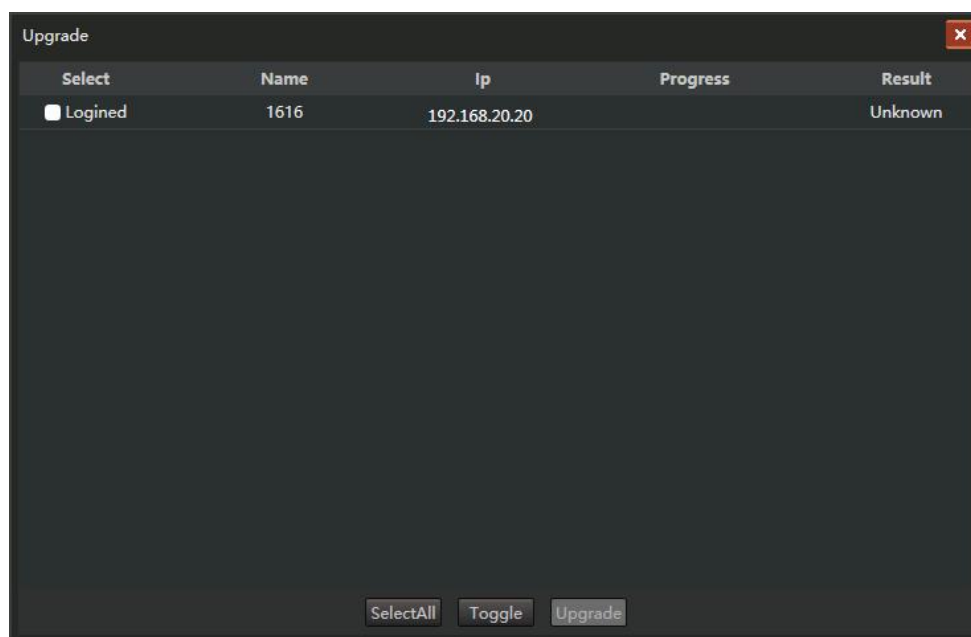

Figure 3-12 Upgrade dialog box

All devices in the device list will be listed in the upgrade dialog, only logged-in devices can be selected for upgrade, Multiple devices can be selected at the same time. After clicking the "Upgrade" button, the "Open" file dialog box will pop up, and the user selects the upgrade package file (.dup), You can use this file to upgrade multiple selected devices simultaneously. During the upgrade process, the Progress column will show the progress of each upgraded device. When the upgrade is complete, the results column shows the reason for the upgrade success or failure. An upgraded device will restart automatically, and the interface needs to be re-logged in before the device can be followed up.

It is important to note that the device cannot be powered off during the upgrade process, otherwise it may cause the device to not restart.

3.4.10 Full

"Select All" menu item from the right-click menu in the Device List area, and check the check box for all devices, that is, select all devices.

3.4.11 Toggle

Selecting the anti-select menu item in the right-click menu in the device list area, will change all selected devices to unchecked, and all unselected devices can be selected.

3.5 Local scene list area

The local scene file can be uploaded to the device, which works by loading the

scene; it can also download a scene in the device as a local scene file, and then upload it to other devices of the same type to realize scene synchronization between different devices. The local scene list area is shown below.

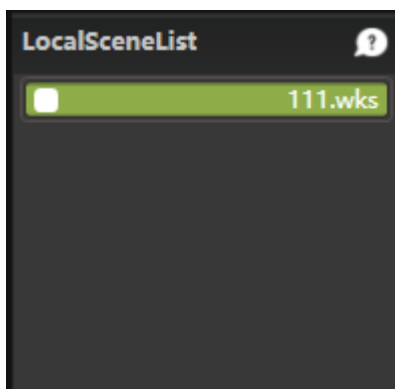

Figure 3-13 Local scene list area

Local scene list area

The local scene list area can list multiple local scene items. The local scene item consists of a check box and a scene name.

Hover the mouse over the local scene item and the device model to which the local scene is directed will appear.

Check boxes are designed to operate multiple local scenarios simultaneously. Removing Scenes and Removing Scenes can operate on multiple local scenarios simultaneously.

Tick local scene

Tick local scenario is the local scenario where the check box is ticked, as shown in the first local scenario in Figure 3-13. Tick the number of local scenes can be 0,1, or more.

Current local scene

The current local scene is the selected local scene in the local scene list, and the background of the current local scene is highlighted, as shown in the second local scene in Figure 3-13. The current local scenario can be 0 or 1.

If the current local scene exists in the local scene list, the parameters of the current local scene will be displayed in the control area, and its status will be displayed in the status bar.

Note that the current device (see section 3.4) and the current local scenario cannot exist simultaneously. when a device in the device list is selected by clicking the left mouse button, the device becomes the current device. At this point, the current local scene in the

local scene list will no longer be selected, that is, the current local scene will no longer be selected. Instead, when clicking the left mouse button to select a local scene in the local scene list, the local scene becomes the current local scene, at which point the current device in the device list will no longer be selected, that is, the current local device will no longer be present.

In particular, when a new workspace is created (or all devices and local scenes in the workspace device list and the local scene list are removed or removed completely), both the device list and the local scene list are empty. At this point, neither the current device nor the current local scene exists, and the control area will be displayed empty, as shown in Figure 3-2.

Select local scene

If one or more tick local scenes exist in the local scene list, select local scenes to tick local scenes for these; if tick local scenes do not exist in the device list, select local scenes as the current local scene.

Removing, deleting operations are valid for all selected local scenarios.

Help

Click the help button in the local scene list area, and help information will appear, as shown in the figure below.

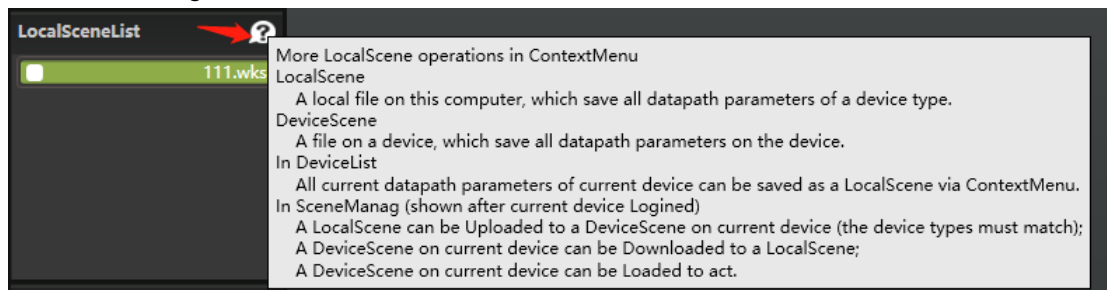

Figure 3-12 Local scene list area help information

3.5.1 Local scene list area right-menu

Right-click in the local scene list area, the right-click menu will appear, as shown in the figure below.

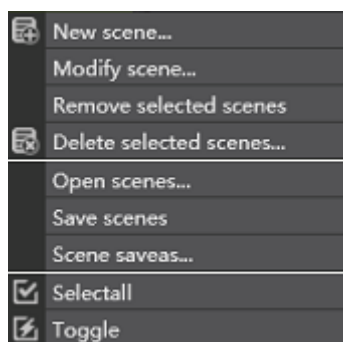

Figure 3-14 Right-click menu for local scene list

The following subsections illustrate the functions of the menu items in the right-click menu.

3.5.2 New scene

“New scene “menu item to create a new local scene and add it to the local scene list. Selecting the menu item will first pop up a Save Scene dialog box to get the name of the scene file saved by the new scene, then a New Scene dialog box will pop up to select the device model for the new scene, fill in the scene description, click OK, the new scene will be added to the local scene list.

3.5.3 Modify scene

“Modify scene “menu item is used to modify the scene description of the current scenario. Double-clicking the left mouse button on the current scene item can also quickly open the Modify Scene dialog box.

3.5.4 Remove the selected scene

“Remove the selected scene “menu item is used to remove the selected scene in the local scene. The scene file of the removed scene still exists in the computer file system and can be added to the scene list again by opening the scene.

3.5.5 Delete the selected scene

“Delete the selected scene “menu item is used to delete the selected scene in the local scene and delete the scene files from the computer file system

3.5.6 Open scene

“Open scene “menu item is used to open one or more local scenario files already in the computer file system and add them to the local scenario list. The last open local scene will automatically become the current local scene.

3.5.7 Save scene

“Save scene “menu item is used to manually save the current local scenario. When the scene is removed, or when the workspace is closed, the local scene is automatically saved. If a program exception exits, the modified parameters in the local scenario may not be saved correctly. manually saving the current local scene ensures that the modified parameters in the local scene are saved.

3.5.8 Save as scene

“Save as scene “menu item to save the current local scene as a new local scene. Selecting the menu item will pop up the Save Scene dialog box to get the file name saved by the local scene. The saved local scene is automatically added to the local scene list.

3.5.9 Full select

Select the Full Select menu item and check the box for all local scene items, that is, select all local scenes.

3.5.10 Toggle

Select “Toggle” menu item to make all selected local scene unchecked and all unselected local scene selected.

3.6 Status

The status bar displays basic information about the current device or the current local scene.

The status bar displays the IP address, login status, and CPU usage of the current device for the current device., as shown below.

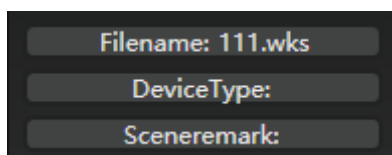

Figure 3-15 Current device status

For the current local scenario, the status bar displays the file name of the current local scenario. as shown below.

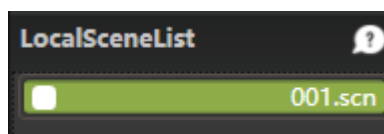
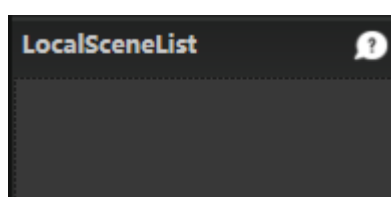

Figure 3-16 Current device status

If there is no current device and current local scenario, the status bar is displayed as empty as follow figure:



4. Workspace interface control area

The control area of the workspace interface displays the parameters of the current device or the current local scene. For unlogged devices, the control area has eight tag pages : " AudioPorts ", " AudioPath ", " Scene Management ", " GPIO", " CenterControl ", " Network set ", " Device Manage "and" User management ". After the device is logged in, the control area will add the "Scene Management" tab. If the logged-in user has administrator rights, the control area will also add the "User Management" tab.

For the local scene, the control area has only two tag pages:" AudioPorts "and" AudioPath ". For the workspace where both the device list and the local scene list are empty, neither the current device nor the current local scene exist, then the control area is empty and no label page appears. For the current device or the current local scene, no matter which tab is selected, the "All Mute" icon will appear in the upper right corner of the control area. click on the icon, all input and output ports will enter the "All Mute" state, click the icon again, all input and output ports will exit the "all mute" state. shortcut key "F12" can quickly switch" all mute "state.

The following sections describe the contents of each tab.

4.1 Audio Ports

The "Audio Ports" tab lists the working status of all audio input and output ports and provides basic control over each input and output port. as shown below.



Figure 4-1 Port

In the tab page, the first line is the input port list to the left and the first line is the input packet list to the right. The second line is the output port list to the left, and the second line is the output packet list to the right. Click the triangle button on the rightmost side of the first line (or second line) to display/hide the input (or output) grouping list separately. number of input and output ports is determined by the device model. for example, the device model S1208 has 12 input ports and 8 output ports.

4.1.1 Input port:

There are multiple input ports in the input port list, one of which has the interface as follows.



Figure 4-2 Input port interface

Port name

User can specify a name for the input port to help remember. Double-click the left mouse button on the port name to modify the port name.

Group name

A port can be added to a packet, and an input port can only add one input packet at the same time. If the input port is added to a packet, the group name button displays the packet to which it is added and appears green. if the port does not join a packet, the group name button appears as "Ungrouped ". Click on the group name button to pop up the control interface to join the group, which can modify the groups added to each port.

"M" Button

"M" to "Port mute "button. press the button, then the port enters the "Port mute" state, at this time, the button is displayed in red. pop up the button and the port exits the "Port mute" state.

the port mute button displays the status of port mute, group mute, and all mute. for the relationship between "Port mute ", " group mute" and "All mute ", see section 4.1.2 for details.

Sensitivity button

Displays current set microphone sensitivity. When the sensitivity is not 0, the button will be displayed in green. Press this button to change the sensitivity setting. a unit of sensitivity is the smaller the d Bu, value, the greater the magnification of the input signal. for example, when the sensitivity is -48dBu, the input signal d Bu, relative to the sensitivity of 0 will be amplified by the circuit for 48dB.

Level

Display port signal level real-time, the value range is -72 dB~0 dB; When the level is close to 0 dB, the input signal may be cut peak, resulting in sound quality damage.

“Gain”

Change the signal gain of the input port in the range of -72 dB~12dB.

“L” Button

Level before change the gain. press the "L" button, the level meter shows the port input level before" gain ", otherwise, the signal level after "gain" is displayed.

“I” Button

Reverse phase. After pressing, reverse the input signal.

“S” Button

Signal generator button. After pressing, the pop-up signal generator setting interface can be set here and the signal generator can be enabled. The button is displayed in pink when the signal generator is enabled. signal generator settings, see section 5.1.

“P” Button

Phantom Power button. Pressing will enable Phantom Power. the button will be shown in yellow when phantom power is enabled.

“Ex”、 “Q”、 “C”、 “G” Button

These buttons enable algorithmic buttons, each corresponding to an algorithm on the input channel connected to the input port, press the button to enable the algorithm, the button will be displayed in green. "Ex" is expansion," Q" is equalization," C" is compression," G" is automatic gain.

“M”、 “F”、 “N” Button

These buttons are added algorithm buttons. Each button corresponds to an algorithm that the input port can add. The input of these algorithms is obtained by mixing multiple

input channels. Press the button to mix this input port to the input of the algorithm, the button is displayed in green. "M" is "Automatic mixing", "F" is "feedback / echo cancellation", "N" is "noise suppression".

Most of the settings for "Input port" are the same as the settings for "Input" in "Audio channel", see section 5.1 for details.

4.1.2 "Port mute", "Group mute" and "All mute"

Support 3 mute modes: "Port mute", "Group mute" and "All mute". Each mode can be set independently.

"All mute" acts on all input and output ports. All input and output ports are muted when enabled this function. All Mute button is located in the upper right corner of the control area, and the shortcut key "F 12" on or off.

"Group mute" acts on all ports added to the group. The group mute button is located in the group control interface, as detailed in 4.1.4.

"Port mute" acts on the port.

If either of the three mutes is enabled, the "M" button on the port will turn red, prompting the port to be mute. For the sake of distinction, the three mute reds have different color depth. If more than two mutes are enabled in the three mutes at the same time, the "M" button will display its corresponding color according to the priority of "port mutes" > "group mutes" and "all mutes".

4.1.3 Output port

Output port interface is shown as below.



Figure 4-3 Output port interface

Output port interface is similar to input port. The description is as follow.

Port name

User can specify a name to the output port to help remember. Double-click the left mouse button on the port name to modify the port name.

Group name

The output port can be added to the output packet, one output port can only add one output packet. If the output port joins a packet, the packet button displays the added packet and displays it in green. If no group is added, "No group" is displayed. Click on this button to pop up the control interface to join the grouping, where you can modify the grouping added to each port.

“M” Button

Port mute button. Press the button, then the port enters the "port mute" state.

For the relationship between "port mute", "group mute" and "all mute", refer to section 4.1.2.

Sensitivity Button

Sensitivity button: Displays the sensitivity of the currently set rear stage device. When the sensitivity is not 0, the button will be displayed in green. Press this button to change the sensitivity setting. A unit of sensitivity is the smaller the dBu value, then the greater the magnification of the output signal. For example, when the sensitivity is -12dBu, amount to the sensitivity dBu, the output signal will be amplified by the circuit for 12dB.

Level

Display port signal level real-time, the value range is -72dB~0dB; When the level is close to 0 dB, the output signal may be cut peak, resulting in sound quality damage.

“Gain”

Changes the signal gain at the output port in the range of -72dB~12dB.

“L” Button

Level before change gain. Press the "L" button, the level meter shows the port output level before "gain", otherwise, the signal level after "gain" is displayed.

“I” Button

Reverse phase. After pressing, the output signal will be reversed.

“X”、“Q”、“D”、“L” Button

These buttons for enable algorithm buttons. Each button corresponds to an algorithm on the output channel connected by the output port respectively. Press the button to enable the algorithm, and the button will be displayed in green. "X" is frequency division, "Q" is equalization, "D" is delay, "L" is limit.

4.1.4 Group

Include input group and output group. Input group. The member of the input group is the input port, and the member of the output group is the output port. The following is an example of input grouping, which is similar to output grouping.

The input group can simultaneously control the mute and gain of multiple input port members added to the group. There can be multiple input port members in an input group. The interface of the input grouping is shown in the following figure.



Figure 4-4 Group interface

Group name: User can assign a name to a group to help remember. Double-click the left mouse button on the group name to modify the group name.

“G” Button: Group member button. If a group member exists in the group, the button is displayed in green. By pressing this button, a group member control interface appears on which members of each group can be changed.

“M” Button: “Group mute” button. Press this button, all the input port in this group will enter the mute status. The button is display in red when enable this button.

“Gain”: Change the gain of all the input port in this group year-on year.

Note that the gain control of each member port by group will only work after logging in to the device.

4.2 Audio channel

“Audio channel “will be described in Chapter 5.

4.3 Scene management

A scene is a collection of audio channel parameters that are stored in the device and can be quickly changed by loading different scenarios to meet the needs of different

application scenarios. The device supports multiple scenarios (the number of scenarios supported by the device is related to the device model).

After loading a scene, the scene will automatically become the current scene and start scene. a change in device parameters automatically saves timing (default is 5 minutes) to the current scenario. When a restart command is sent to the device, the device automatically saves the changed parameters to the current scene before restarting, ensuring that the device always uses the latest parameters of the current scene. If the device parameters change after the device has not reached the time of automatic saving abnormal power down, then the device parameters change will not be saved. user manually save the scene after changing the parameters can avoid this situation.

Usually the start scene is the same as the current scene, and the user can also specify other scene other than the current scene as the start scene. When the device starts, the scene specified by the start scene is automatically loaded. When the startup is complete, the startup scenario becomes automatically the current scenario.

When the device leaves the factory, both the current scene and the startup scenario are set to scenario 1.

Note that the device scene is a scene that is saved in the device and used by the device and can work by loading the scene. while the local scene as described in section 3.5 is the scene saved in the computer, used by the interface, for offline editing of the scene. device scene can be downloaded to the computer to become local scene, and local scene can also be uploaded to the device to become device scene.

The interface for scene management is shown below. eight device scenes are listed in the figure. In each scene, you can set "scene name" for the scene to help remember. "Available" means that the device scene is not empty and can be used, for example, by "loading "," set to start" and "downloading ". Unusable device scene become available after uploading or saving. The "current scene" represents the scene in which the device is currently used, and the "start scene" represents the scene in which the device will be loaded automatically the next time the device is turned on.

The device scene can be downloaded to the local scene list, the scene in the local scene list, or uploaded to the device scene.

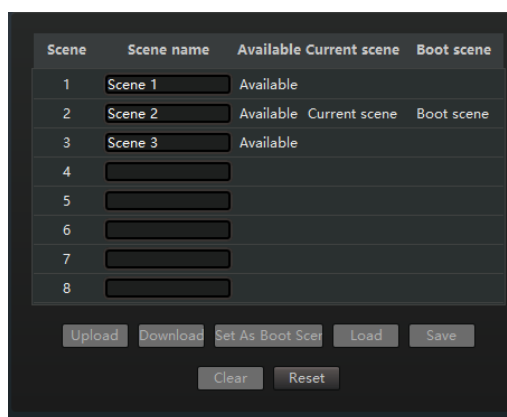

Figure4-5 Scene management

Upload: Place a local scene (.scn) file uploaded to selected scene.

Download: Download the selected scene to the computer file system and save it as a local scene (.scn) file and added to the local scene list.

Save: Save the current parameters of the audio channel in the device to the selected scene.

Load: Load the parameters of the selected scene into the device, and the loaded scene will automatically become the current scene and start scene.

Set to start scene: Set the selected scene to start scene, the next time the device starts, the scene will be automatically loaded and made the current scene.

Clear: Empty the selected scene to make it unavailable.

Reset: Restore all device scenarios to ex-factory configuration status.

4.4 GPIO

GPIO interface is used to configure functionality on the device GPIO port. Different models of devices provide different numbers of GPIO ports. Each GPIO port can be configured as an input or output independently, specifying its functions as input or output. GPIO configuration interface is shown below.

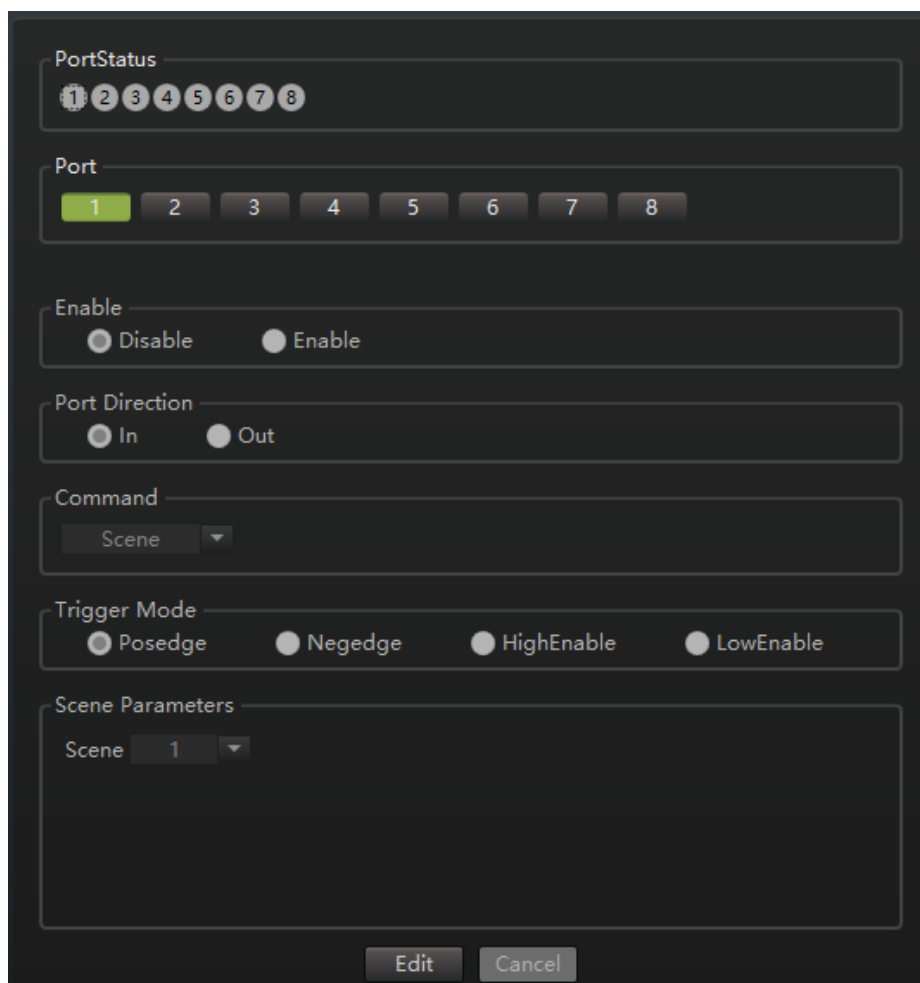

Figure 4-8 GPIO configuration interface

Port name

List the GPIO ports supported by the device (the number of GPIO ports may vary for different device models), select different GPIO ports to view or modify the configuration of that port.

Enable

Disable or enable the GPIO port.

Port direction

Configure the direction of GPIO port. When set the input, the external device controls the device by GPIO the port input signal, setting the specific parameters inside the device to a specific value. When set the output, the device outputs the signal to the GPIO port according to the internal state, and the specific level is output when the specific parameters inside the device take a specific value.

When the port direction of the GPIO is configured as input, its input level defaults to a high level. if it is short to ground, the input level becomes low. the GPIO 1 is short

connected to the device ground by the wire as shown below, thus making the G PIO port 1 input low level.

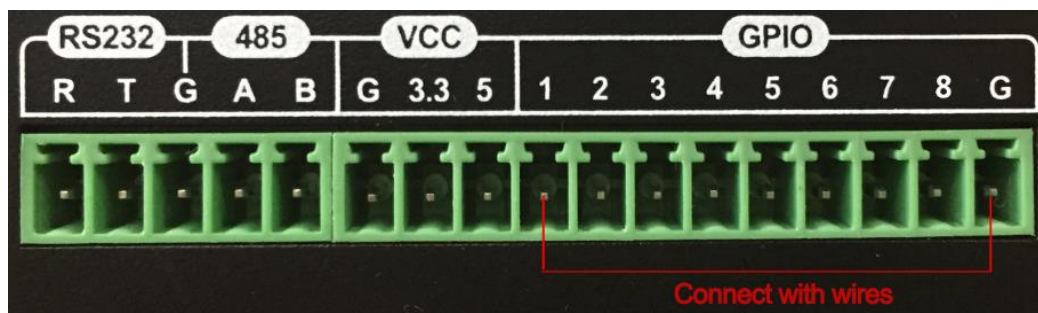

Figure 4-9 GPIO Pin input example

Command

The command specifies the function implemented GPIO port. commands vary according to the port direction. For the input, the command has "Scene "," Mix "," Increase volume "," Mute "," All mute" and "Send serial command ". For the output, the command has " Scene "," Mix "," Level "," Mute "and" All mute ".

Trigger mode

There are four trigger modes: "Rising edge "," Falling edge "," High level enable "and" Low level enable ". meaning is shown in the table below.

Trigger mode	Input	Output
Rising edge	Input signal from low to high enable, from high to low no action	No definition
Falling edge	When the input signal is powered from high to low, there is no movement from low to high	No definition
High level enable	When input signal is enabled from low to high, it is forbidden to change from high to low	Output high level when internal state meets trigger condition and low level when not satisfied
Low level enable	Enables input signals from high to low and is prohibited from low to high	Output low level when internal state meets trigger condition and high level when not satisfied

When the direction is input, if the command is an action, the command has two trigger modes," Rising edge "and "Falling edge ", indicating that the command action is triggered at the "rising edge" or "Falling edge" of the input level.

When the direction is input, if the command has two states of true or false; then the

command has four trigger modes: " Rising edge ", " Falling edge ", " High level enable "and" Low level enable ". If the trigger mode is set to an edge trigger, the device sets the command to the specified value configured when the input signal appears a specified edge. Other times the order remains the same. if the trigger mode is set to level trigger, the command is set to the configured specified value when the input signal is the specified level, and the command is set to the opposite value of the configured specified value when the input signal is not the specified level.

When the direction is output, the command has two trigger modes: " High level enable "and" Low level enable ". GPIO the port outputs the specified level when the command inside the device takes the specified value configured, otherwise the opposite level of the specified level is output.

Different commands have different parameters. Each command is described in GPIO following sections.

4.4.1 Scene

The interface of scene as below.

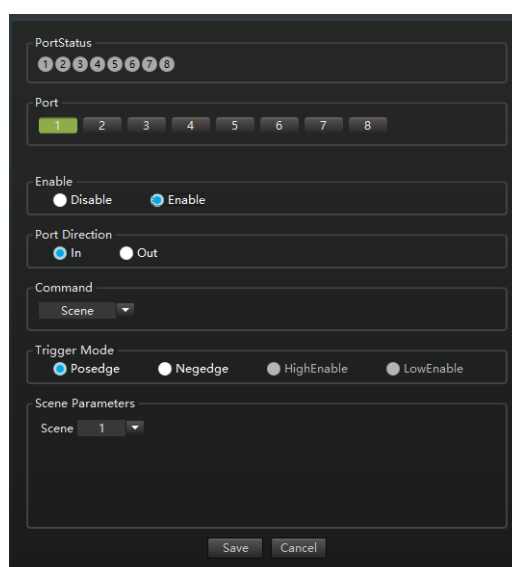

Figure 4-10 GPIO "Scene" command configuration interface

The parameters of the scene command are "scene number "

When the command direction is input, the trigger mode has a "Rising edge and "Falling edge", and when the GPIO port input signal appears an edge specified by the trigger mode, the device loads the scene specified by the scene number as the current scene.

When the command direction is output," Trigger mode "has" High level enable "and" Low level enable ". when the device takes the scene specified by "Scene number" as the

current scene, the GPIO port outputs the level specified by "Trigger mode ". Otherwise, the level opposite to the specified level is output.

4.4.2 Mix

Mix command interface as below.

The screenshot shows a configuration interface for the GPIO "Mix" command. It includes sections for "PortStatus" (buttons 1-8), "Port" (buttons 1-8, with 1 highlighted), "Enable" (radio buttons for Disable and Enable), "Port Direction" (radio buttons for In and Out), "Command" (dropdown menu showing Mix), "Trigger Mode" (radio buttons for Posedge, Negedge, HighEnable, and LowEnable), and "Mix Parameters" (dropdown menus for OutPort and InPort, both set to 1). At the bottom are "Save" and "Cancel" buttons.

Figure 4-11 GPIO "Mix" command configuration interface

The parameters of the mix are "Input port" and "Output port".

When the command direction is input, "Trigger mode" has "Rising edge", "Falling edge", "High level enable" and "Low level enable". If "Trigger mode" is along trigger, the device mixes the specified input port into the specified output port when the GPIO port input signal appears "Trigger mode". In other cases, the mixing setting remains unchanged. If trigger mode is a level trigger, the device remixes the specified input port to the specified output port when the level specified by trigger mode appears in the input

signal. when the input signal is not a level specified by trigger mode, the device removes the remix from the specified input port to the specified output port.

when the command direction is output," trigger mode "has" high level enable "and" low level enable ". when the specified input port is remixed to the specified output port, the G PIO port outputs the level specified in "trigger mode ". otherwise, the level opposite to the specified level is output.

4.4.3 Increase volume

Increase volume interface as below.

The screenshot shows a configuration interface for the GPIO "Increase" command. It includes sections for PortStatus, Port, Enable, Port Direction, Command, Trigger Mode, and Volume Parameters. The Volume Parameters section features a slider for Volume Increase Value ranging from -12 to 12 dB, currently set at 0.00.

Figure 4-12 GPIO "Increase" command configuration interface

The parameters for increased volume command are "input/output", "Port" and "Volume increment". First two parameters specify the port to increase the volume, and the volume increment specifies the added value of the volume at each trigger command in dB. If the value is less than 0, then the volume will be reduced each time the command is triggered.

The direction of increasing the volume command can only be input. "Trigger mode" has "Rising edge" and "Falling edge ". A specified volume increment is increased (reduced when volume increment is negative) when the G PIO port input signal appears

along the specified "Trigger mode ".

4.4.4 Level

Level command interface as below.

The screenshot shows a configuration window for the GPIO "Level" command. It includes sections for "PortStatus", "Port", "Enable", "Port Direction", "Command", "Trigger Mode", and "Level Parameters". The "Port" section has button 1 selected. The "Enable" section has "Enable" selected. The "Port Direction" section has "Out" selected. The "Command" section has "Level" selected. The "Trigger Mode" section has "HighEnable" selected. The "Level Parameters" section has "In" selected for direction, "1" for level, and a "Threshold" slider set to 0.00. The slider scale ranges from -72 to 0. "Save" and "Cancel" buttons are at the bottom.

Figure 4-13 GPIO "Level" command configuration interface

The parameters of the level command are "Input/output ", " Port" and "Threshold ". the first two parameters are used to configure the port that the command acts on, and the "Threshold "is used to configure the comparison threshold of the level.

The direction of the level command can only be output," Trigger mode "has" High level enable "and" Low level enable ". when the level of the specified port is greater than or equal to the specified level threshold, the G PIO port outputs the level specified in "Trigger mode ". otherwise, the level opposite to the specified level is output.

4.4.5 Mute

Mute command configuration interface as below.

The screenshot shows a configuration interface for the GPIO "Mute" command. It includes the following elements:

- PortStatus:** A row of eight buttons labeled 1 through 8.
- Port:** A row of eight buttons labeled 1 through 8, with button 1 highlighted in green.
- Enable:** Two radio buttons: "Disable" (selected) and "Enable".
- Port Direction:** Two radio buttons: "In" (selected) and "Out".
- Command:** A dropdown menu currently showing "Mute".
- Trigger Mode:** Four radio buttons: "Posedge" (selected), "Negedge", "HighEnable", and "LowEnable".
- Mute Parameters:** Two dropdown menus, the first showing "In" and the second showing "1".
- Buttons:** "Save" and "Cancel" buttons at the bottom.

Figure 4-14 GPIO "Mute" command configuration interface

The parameters of the mute command are "Input/output" and "Port ", which are used to configure the port that the command acts on.

when the command direction is input," trigger mode "has" Rising edge "," Falling edge "," High level enable "and" Low level enable ". if "trigger mode" is along trigger, the specified port enters "Port mute" mode when the GPIO port input signal appears the edge specified by "trigger mode ". In other cases, the "Port mute" setting remains unchanged. if triggered for "trigger mode" is level, the specified port enters "Port mute" mode when the input signal is the level specified for "trigger mode ". when the input signal is not the level specified in trigger mode, the port is specified to exit port mute mode. when the command direction is output," trigger mode "has" high level enable "and" low level enable ". GPIO port outputs the level specified in "trigger mode" when the specified port is in "Port mute" state, otherwise, outputs the level opposite to the specified level.

4.4.6 All mute

All mute command configuration interface as below.

Figure 4-15 GPIO “All mute” command configuration interface

All mute command configuration has no parameters.

When the command direction is input, trigger mode "has" Rising edge ", Falling edge ", High level enable "and" Low level enable ". if "trigger mode" is along trigger, all input and output ports of the device will enter "all mute" state when the GPIO port input signal appears the edge specified by "trigger mode ". In other cases, the "All mute" setting remains the same. if "trigger mode" is a level trigger, all input and output ports of the device will enter "All mute" state when the input signal is the level specified by "trigger mode ". when the input signal is not the level specified by" trigger mode ", all input and output ports of the device will exit "All mute" state.

When the command direction is output, trigger mode "has" High level enable "and" Low level enable ". when the input and output ports of the device are in the "all mute" state, the G PIO port outputs the level specified in "trigger mode ". otherwise, the level opposite to the specified level is output.

4.4.7 Send serial port command

Send serial port command configuration as below.

Figure 4-16 GPIO "Send serial port" command configuration interface

"The parameters of "Send serial port command" are "Serial port number" and "Serial port command "." Serial port command" is a string of binary byte data, input in hexadecimal form on the interface, and the bytes are separated by spaces. For example, "01" 02 03 04" is a four-byte serial port command.

"Send Serial Command" direction can only be input," trigger mode "has" Rising edge "and" Falling edge "two, when the GPIO port input signal appears" trigger mode "specified edge, the device will send the specified serial port command to the specified serial port.

4.5 Central control

The central control equipment can send the central control command to the equipment through the serial port to realize the control of the equipment. In the "Central Control" tab, the user can select the functions listed in the interface, the interface will display the corresponding central control commands of these functions, and the user can

copy the generated central control commands to the central control device for use. after logging into the current device through the serial port (see 3.4.2), the generated central control command can also be sent to the current device through the serial port to control the device, thus testing the effectiveness of the generated central control command. the user can also directly enter the central control commands (these central control commands are given by the central control command manual of this device) and send them to the device to test the effectiveness of the central control command.

The central control interface is shown as below.

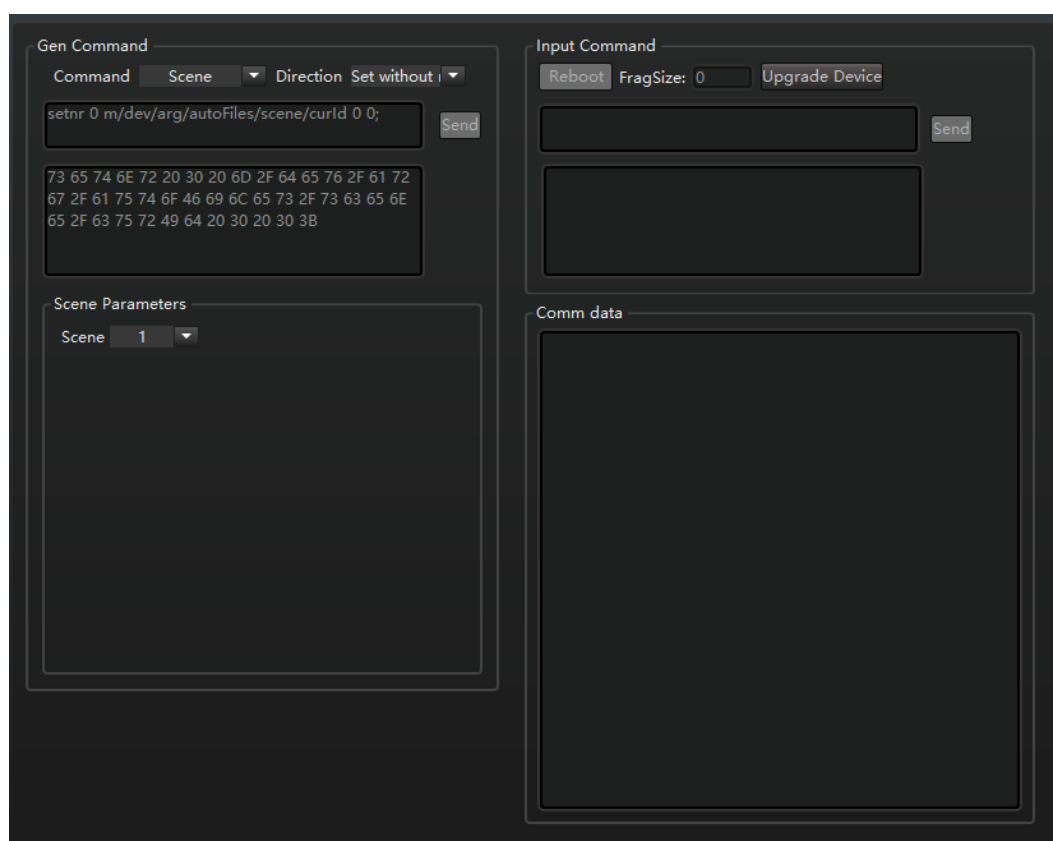

Figure 4-17central control

On the left is the generate command area. Select different commands, directions, and parameters, the corresponding central control commands will be displayed in the generate command box. After logging into the device through the serial port, you can click the "Send" button to send the central control command to the device to test its effectiveness.

“Command”: The central control command is the same as the GPIO command in Section 4.4, see Section 4.4 for the parameters and meaning of each command.

“Direction”: Three values for Direction, “Set”, “Set no response”, “Get”.

Command parameters: Are determined by “Command” and “Direction” In the

example shown above, the direction is set, the command is scene, and the command parameter is scene number. If the "Scene Number" value is 1, the generated central control command is "set 0m/dev/arg/autoFiles/scene/curlId 0", For the format and meaning of the command, see the command manual.

The right side is the "Input command" area, after logging into the device through the serial port, the user can enter the central control command here, click the "Send" button to send the command to the device, and test its validity.

Whether to send "Generate command" or "Input command", the central control commands sent and accepted by the interface are displayed in the "communication data" text box, as shown in the figure below.

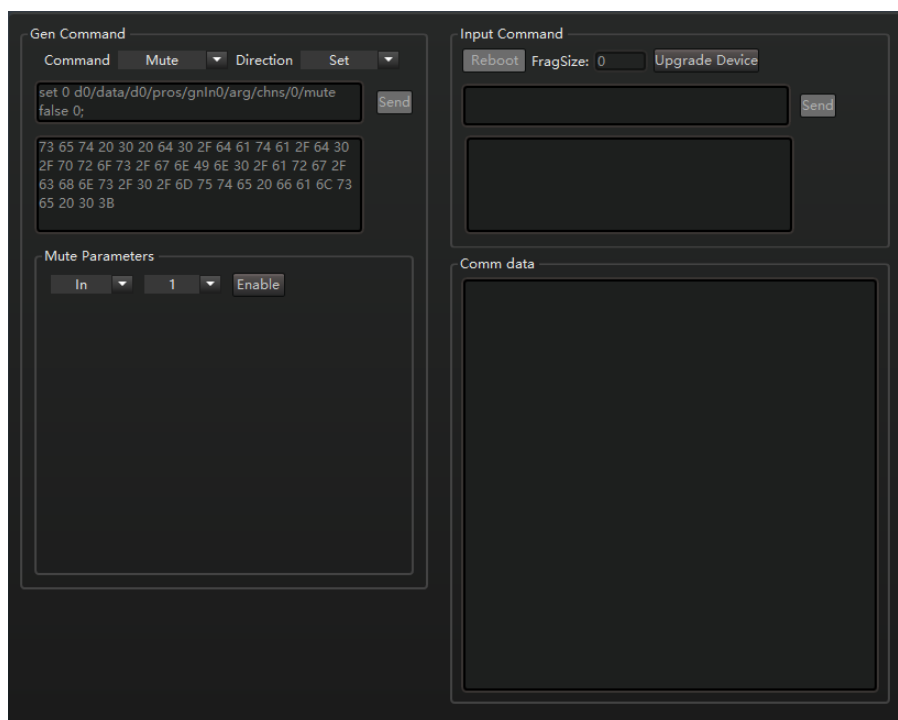

Figure 4-18 Central Control Example

In the image above, a total of two central control commands are sent. In the last central control command, "command" is "Mute", "direction" is "set", parameter is "Input", "1" enable; click the "Send" button, the "Communication data" box shows the result of interface and device communication, because "direction" is "Set", the device will return a reply, return 0 indicates success, return 1 indicates failure. The figure above returns 0, indicating that input port 1 has been successfully set to mute.

The "Enter Command" section also has "Restart", "Upgrade Device" buttons, to achieve device restart and upgrade operations. Its function is the same as "restart" and "upgrade" in the device settings. but the interaction procedure of the protocol is displayed

in the communication data text box.

4.6 Network settings

Network settings can view and set the parameters of the device, including the network, serial port two parts. as shown below.

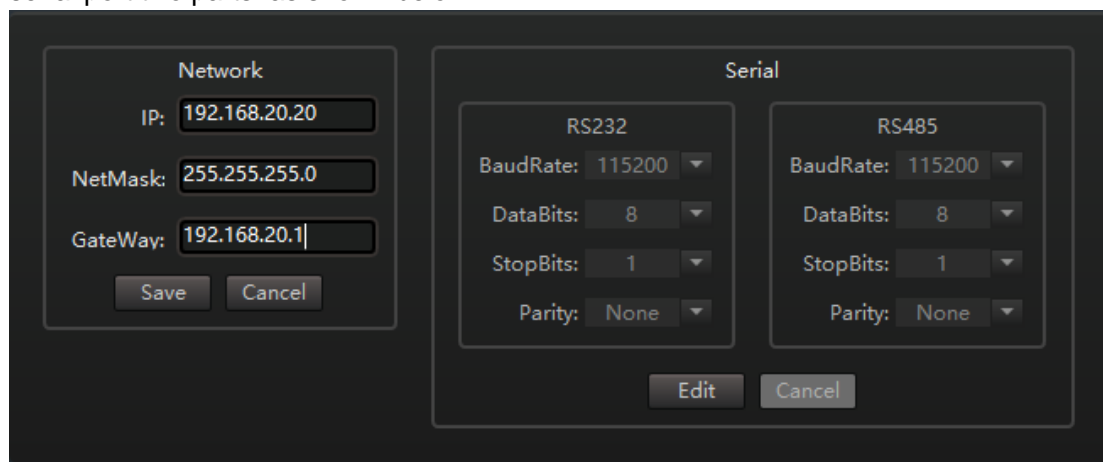
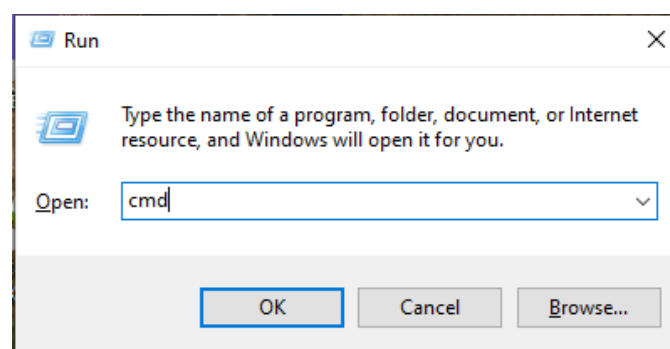

Figure 4-6 Network Settings

4.6.1 Network settings

View and modify the network information of the device. Click Modify to modify the IP address, subnet mask, and gateway of the device. After the modification is complete, click "Save "(after clicking" Modify ", the "Modify" button will be renamed "Save" button), the modification will be saved to the device and take effect immediately. The current network connection will be interrupted, and the interface needs to use the modified device IP address as the I P address of the login device (User can modify the IP address of the login device by "Modify the device ", see 3.4.6) to re-login the device for subsequent operation. clicking "Cancel" will cancel the modification.

The following is to view the IP address of the computer, open the "Run" window by "Windows+R "key, and then enter the CMD into the command prompt window, as shown in the following figure:



When you enter the command window,enter "ipconfig/all",then press enter button,you

can check the detail IP configuration information of the computer ,as following figure:

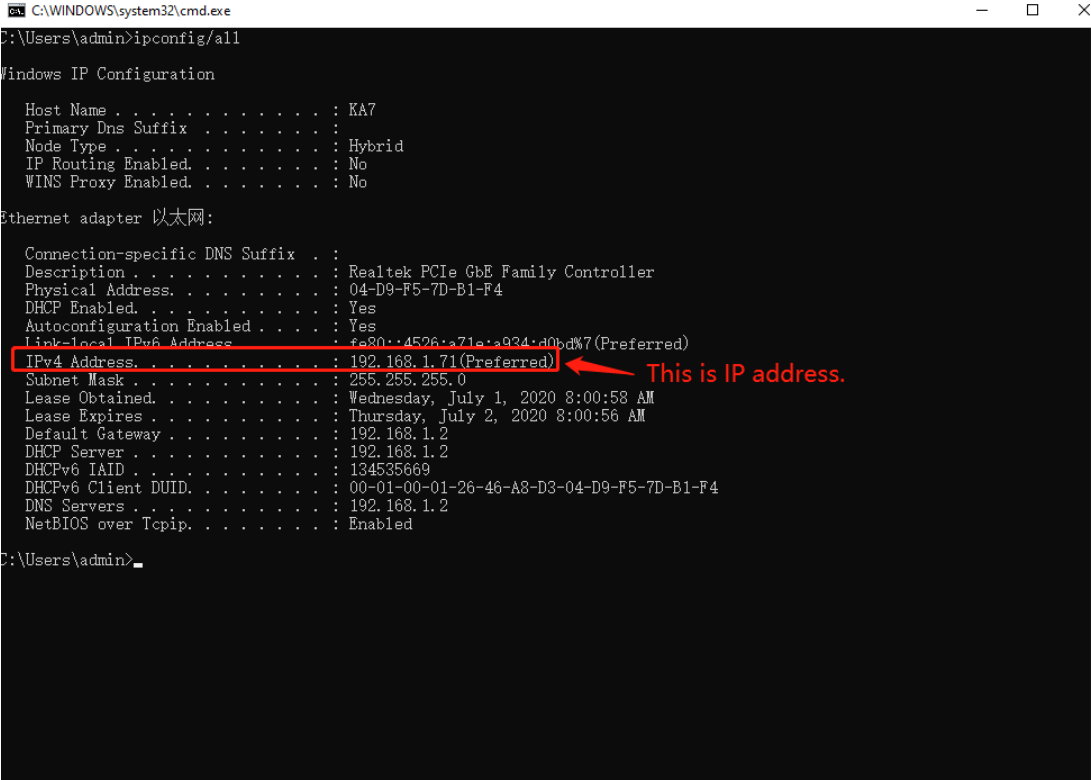

```
C:\WINDOWS\system32\cmd.exe
C:\Users\admin>ipconfig/all

Windows IP Configuration

Host Name . . . . . : KA7
Primary Dns Suffix . . . . . :
Node Type . . . . . : Hybrid
IP Routing Enabled. . . . . : No
WINS Proxy Enabled. . . . . : No

Ethernet adapter 以太网:

Connection-specific DNS Suffix . . :
Description . . . . . : Realtek PCIe GbE Family Controller
Physical Address. . . . . : 04-D9-F5-7D-B1-F4
DHCP Enabled. . . . . : Yes
Autoconfiguration Enabled . . . . . : Yes
Link-local IPv6 Address . . . . . : fe80::4526:a71e:a934:d0bd%7 (Preferred)
IPv4 Address. . . . . : 192.168.1.71(Preferred) ← This is IP address.
Subnet Mask . . . . . : 255.255.255.0
Lease Obtained. . . . . : Wednesday, July 1, 2020 8:00:58 AM
Lease Expires . . . . . : Thursday, July 2, 2020 8:00:56 AM
Default Gateway . . . . . : 192.168.1.2
DHCP Server . . . . . : 192.168.1.2
DHCPv6 IAID . . . . . : 134535669
DHCPv6 Client DUID. . . . . : 00-01-00-01-26-46-A8-D3-04-D9-F5-7D-B1-F4
DNS Servers . . . . . : 192.168.1.2
NetBIOS over Tcpip. . . . . : Enabled

C:\Users\admin>
```

Note: Add I P address cannot conflict IP with other computers or devices, verify that this IP exists before adding.

Verify that the add segment successful or nor, use the “Windows+R” key to open the "run" window, and then enter "CMD" to opening of the computer DOS command window input “ping 192.168.20.20”, press enter key appear information as shown in the figure means adding successful.

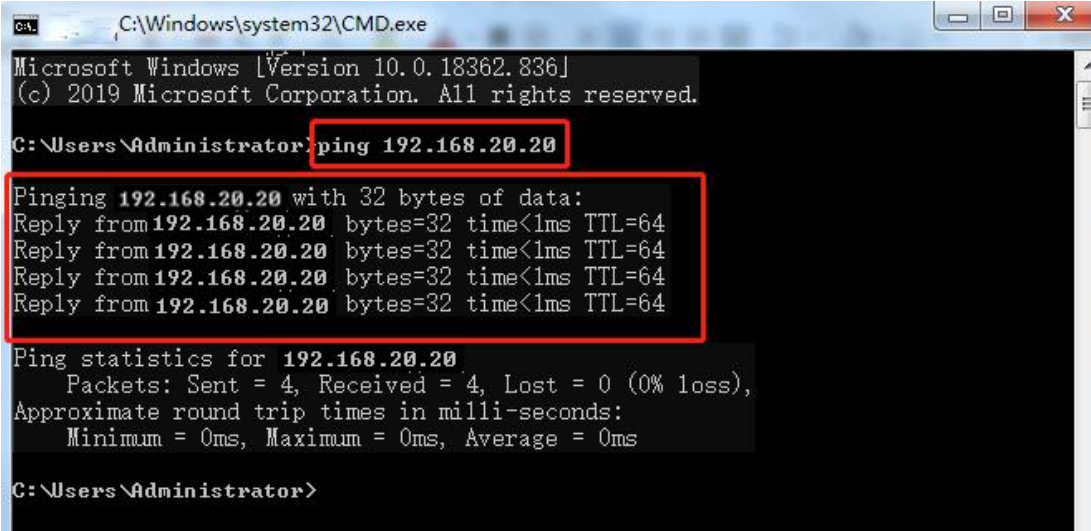

```
C:\Windows\system32\CMD.exe
Microsoft Windows [Version 10.0.18362.836]
(c) 2019 Microsoft Corporation. All rights reserved.

C:\Users\Administrator>ping 192.168.20.20

Pinging 192.168.20.20 with 32 bytes of data:
Reply from 192.168.20.20 bytes=32 time<1ms TTL=64
Reply from 192.168.20.20 bytes=32 time<1ms TTL=64
Reply from 192.168.20.20 bytes=32 time<1ms TTL=64
Reply from 192.168.20.20 bytes=32 time<1ms TTL=64

Ping statistics for 192.168.20.20
    Packets: Sent = 4, Received = 4, Lost = 0 (0% loss),
    Approximate round trip times in milli-seconds:
        Minimum = 0ms, Maximum = 0ms, Average = 0ms

C:\Users\Administrator>
```

4.6.2 Serial port settings

View and modify serial port parameters. Click on "Modify" to modify the "Baud rate ", "Data bit ", " Stop bit" and "Check bit" of the serial port. after the modification is completed, click "Save "(after clicking " Modify ", the "Modify" button will be renamed "Save" button), the modification will be saved immediately. clicking "Cancel" will cancel the modification.

4.7 Device manage

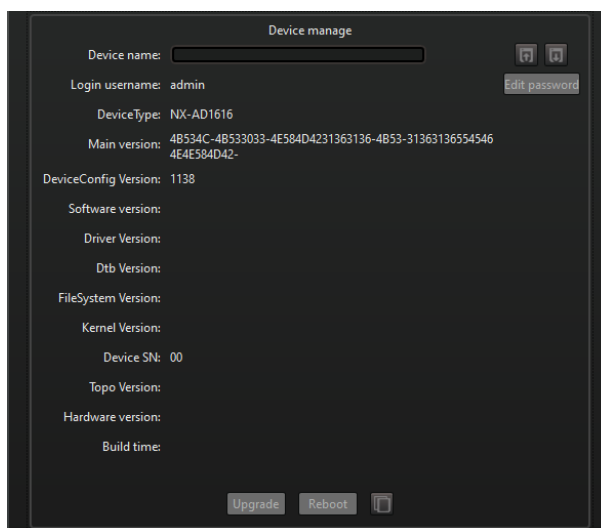

View device name, login user name, device model, software version, generation time, hardware version and globally unique device serial number. click on the "copy device information to clipboard" button, the user can copy the above information of the device to the clipboard of the operating system, and then paste it into other programs, so that the device information can be easily provided when obtaining technical support services.

In device management, you can modify the "Device name ", modify the password of the login user," Upgrade" device, and "Restart" device. Among them, the operation of the "Upgrade" device is similar to that in 3.4.9, but only the current device can be upgraded here.

Device name and device local alias

Device name refers to the name saved in the device that can be logged into multiple interfaces of the same device to view. The device name will also be displayed when searching for the device. in the device list (see section 3.4), the local alias of the device is displayed. Local aliases are aliases taken by the interface program for the device and are only saved in the workspace and are not viewed by others who log in to the same device.

In device management, the "local alias → device name ", " device name → local alias" button is provided to achieve synchronization between "local alias" and "device

name ".

4.8 User management

Only user login devices belonging to the administrator group appear on the User Management tab.

All users are divided into two groups, "admin"(Administrator) group and "user "(User) group. The two groups have different user management rights. Administrator group can add, delete other users, modify the password of other users, and user group can only modify the password of this user; there is an "Admin"(Super administrator) user in the administrator group, the highest authority, this user cannot be deleted. other than "admin" themselves, other users cannot modify admin password. In user management, you can add, delete, modify the user's password and group. The user management interface is shown below.

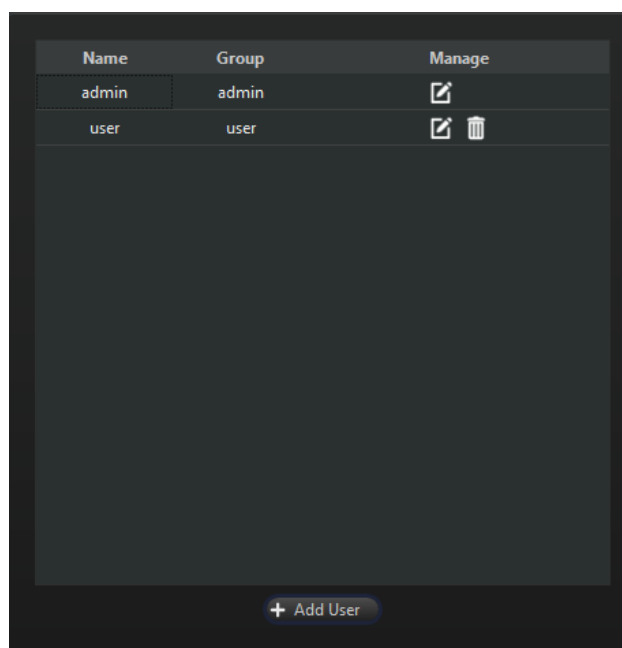

Figure 4-7 User management

User can "add users", "Delete users" and "Modify user" modify passwords and groups through button on the interface.

5. Audio Path

Section 4.1 illustrates the "Audio port" tab for the workspace interface control area. in the "AudioPort" tab, only the audio channel of the device can be basically controlled. And the "AudioPath" label page will be illustrated in this chapter. In the "AudioPath" tab, you can achieve more control over the parameters of the audio channel. The Audio Channel

tab is shown below.

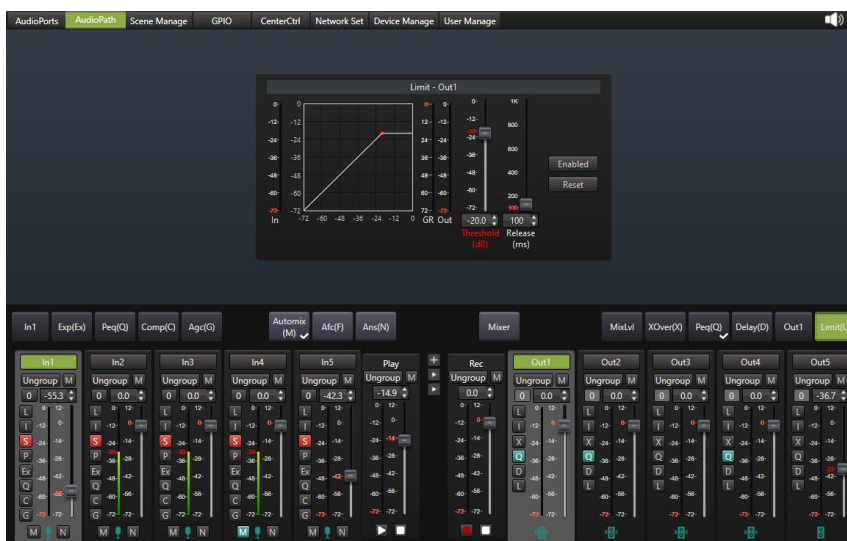



Figure 5-1 "AudioPath" tab

The bottom left of the "AudioPath" tab is the input port list, and the bottom right is the output port list. The middle line is the algorithm list, which is divided into three segments: "Input", "Mix" and "Output". The algorithms in the algorithm list are arranged according to the processing order. The top is the algorithm control area.

The operation of the input port list and the output port list is the same as the input port list and the output port list in the AudioPort tab. See section 4.1 for details.

Click the "expand channel" button between the input port list and the output port list , The algorithm control area will list the output levels of all algorithms passing through from an input port to the end of an output port, as shown in the figure below. can help troubleshoot by looking at the output levels of these algorithms.

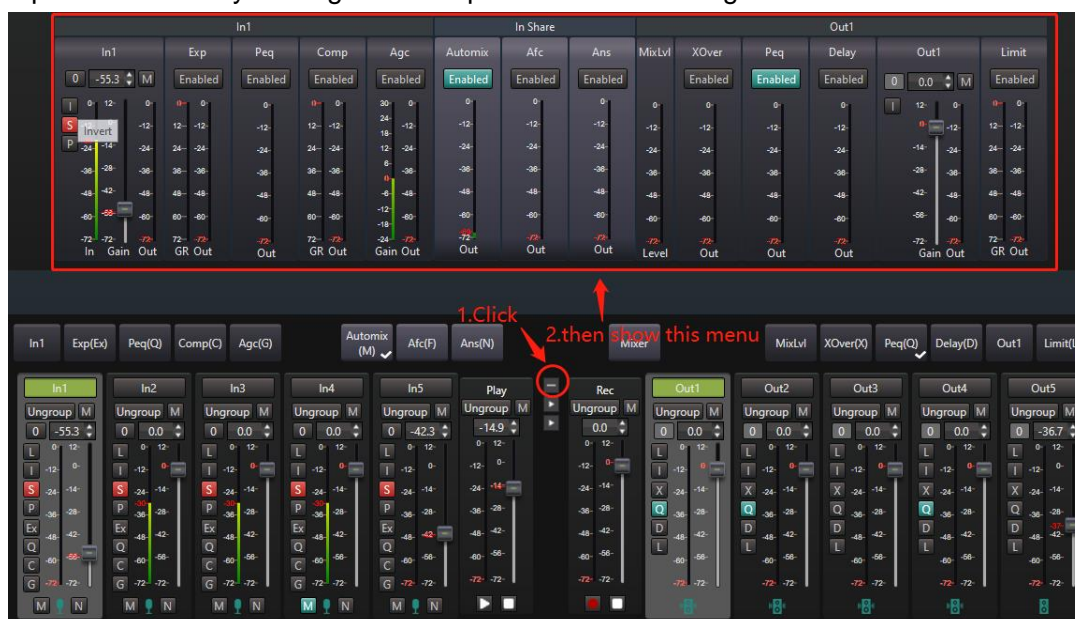

Figure 5-2 Extended channel interface

User also can copy one channel's algorithm parameters to others by “copy” and “paste” function. After copying the parameters of an algorithm (figure 5-3), the user can paste it into other algorithms of the same type. (figure 5-4) The copy and paste function can synchronize the parameters of the same type of algorithm within the device, between devices, between devices and local scenarios. Some algorithms contain graphs, right-click on the graph, will appear graph right-click menu, as shown in the figure below.

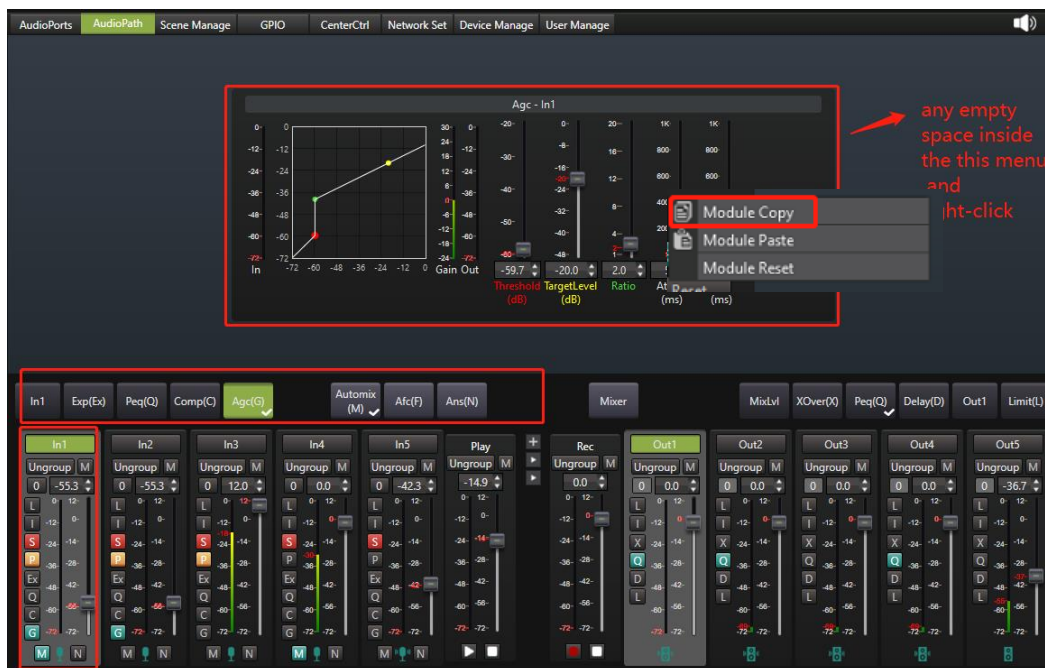

Figure 5-3



Figure 5-4

The following sections illustrate the interface of each algorithm.

5.1 Input

Click the input port name in the algorithm list and the algorithm control area will display the "Input" interface, as shown below. You can change the settings of the input port here

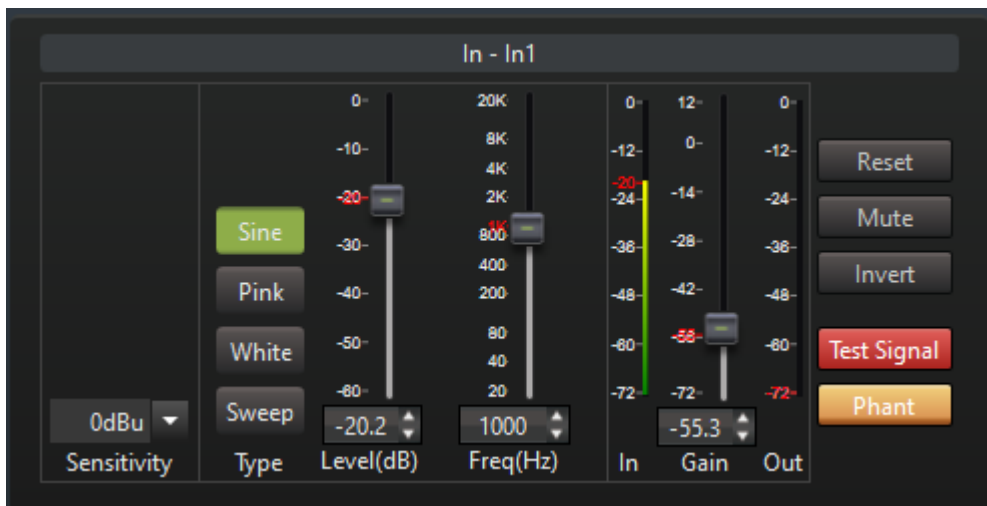

Figure 5-6 Input

Sensitivity

When the input port is connected to the microphone, it is used to match the sensitivity of the microphone by setting the sensitivity. for a description of sensitivity refer to section 4.1.1.

Signal generator parameters

The equipment has built-in signal generator, which can be used to test and debug the equipment. Change the Type, Level parameters to set the type and level of the signal generated by the signal generator. "Type" includes "Sine wave ", " Pink noise ", " White noise" and "Sweep frequency ". for sine waves, the "frequency" of sine waves can also be set. for the sweep signal, the interface is shown below.

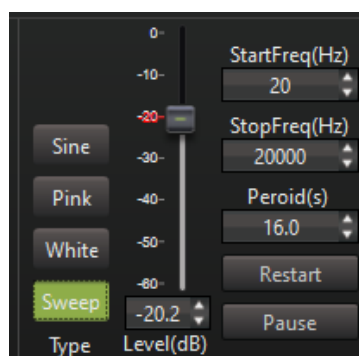

Figure 5-7 Sweep frequency parameters

The "Start frequency", "End frequency" and "Sweep period" of the sweep signal can be set, and the sweep signal can be "Restarted" or "Paused".

After the signal generator parameters are set, press the "Test signal" button (as below figure 5-7) to output the signal generated by the signal generator into the input channel. When the test signal button pops up, the signal of the input channel is the signal entered from the input port.

Gain, input, output level

The gain elevates or attenuates the input signal. The input level is the level value before the gain and the output level is the level value after the gain.

Reset

Restores all parameters of the module to the factory setting.

Mute

Press button to enter "Port mute" state, pop up button to exit "Port mute" state. For "Port mute", see section 4.1.2.

Phase

Inverting the input signal. "Inverse Phase" function can enhance or attenuate the interaction between two homologous signals as needed.

Test signal

Press the test signal button, the signal of the input channel comes from the signal generator. When the button is popped up, the signal of the input channel comes from the analog input port.

Phantom power

Press this button to enable phantom power. Used to power capacitive microphones. If the port is connected to a line input or a non-capacitive microphone, do not turn on phantom power, otherwise the input device may be damaged.

5.2 Extension

The extender compresses the small input signal below the threshold in proportion, effectively eliminating or reducing the ambient noise collected by the microphone and the noise introduced on the line. the reason why this algorithm is called an extender is because this algorithm makes the small signal smaller, thus extending the dynamic range of the input signal. This extension is called a "Downward extension".

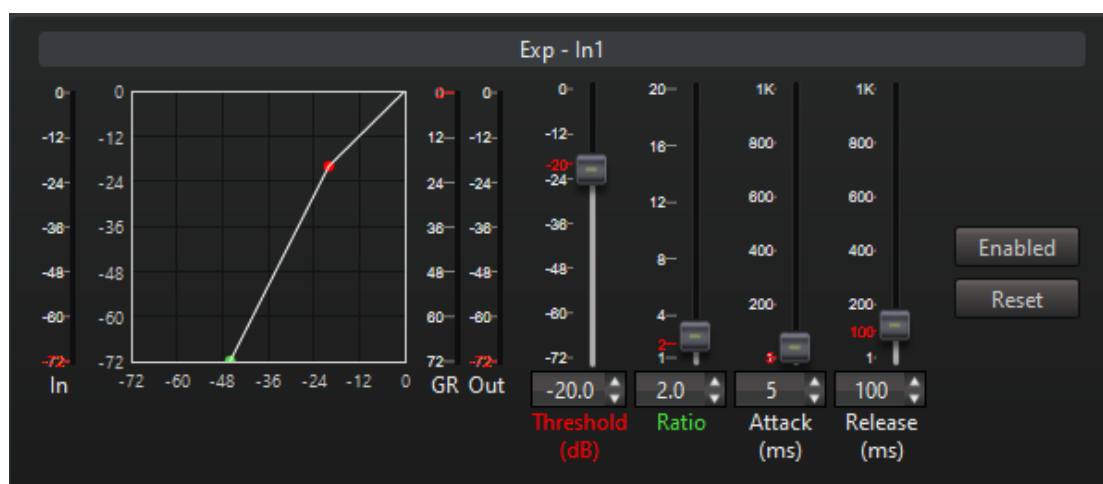

Figure 5-8 Extension interface

"Input" level," Compression "level and "Output" level : Display input level, compression level and output level real time. Output level=Input level - Compression level.

Graph: The horizontal coordinate of the graph is the input level and the vertical coordinate is the output level. the graph shows the corresponding relationship between the output level and the input level. When the input level is less than the threshold, the output level will be compressed by ratio. Control points can be dragged on the graph to adjust the threshold and ratio.

Threshold, Ratio: It can be seen from the graph that the output level is not compressed when the input level is greater than the threshold. When the input level is less than the threshold, the output level will be compressed by ratio. the larger the ratio, the more compressed. When the ratio is maximized, the expander is close to the noise gate. If the input is a microphone, the threshold can be adjusted appropriately, and the ratio can be adjusted moderately, which can avoid dropping words when speaking far from the microphone. If the input is line input, only line noise in the input noise at this time, the threshold can be adjusted moderately and the ratio moderately.

Start time and recovery time: The start time is the time when the extender enters the extended state, and the recovery time is the time when the extender recovers from the

extended state to the normal state. the larger these two values are set, the less easily the sound is distorted by the gain mutation, but the slower the response of the algorithm is. normally, the recovery time should be greater than the start time.

Enable: press enable algorithm, bounce not enable algorithm.

Reset: Restore all parameters of the algorithm to the factory setting.

5.3 Equalizer

Equalizer compensates and modifies the frequency characteristics of sound to satisfy the desired auditory perception. There are equalizers on the input channel and the output channel, and the spectrum equalization is adjusted for the input channel and the output channel respectively. The interface of the equalizer is shown below. Different equipment models, equalizer types and segments may vary, whichever is the actual equipment.

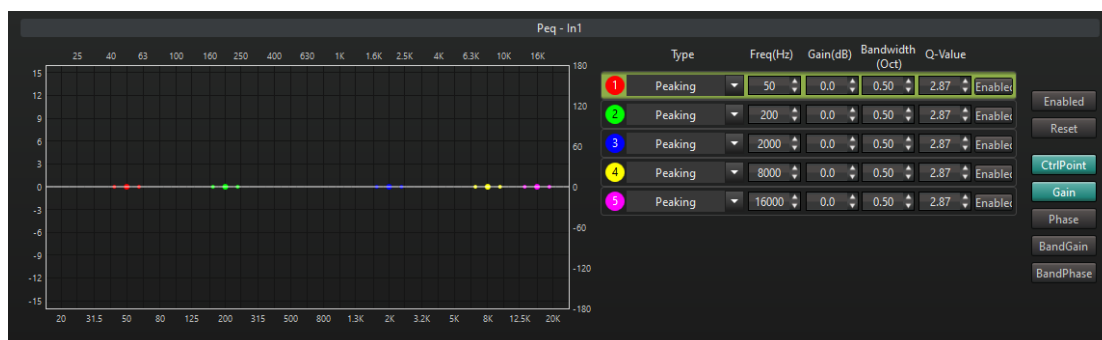

Figure 5-9 Equalizer interface

Equalizer consists of multiple segments. All or part of the "type "," frequency "," gain "," bandwidth "/" quality factor" parameters can be set for each segment. each segment can be enabled or closed by the enable button.

Type: The filter type supported by the device is shown in the table below. Different filter types can adjust different parameters, as detailed in the table.

Type	Role	Support Parameters
Peak	Regulate the spectrum equalization near the center frequency	Frequency, Gain, Bandwidth/Quality Factor
Notch	A special peak with narrow bandwidth and large attenuation, which can be used for feedback elimination. Fixed gain dB. -80 can only adjust the bandwidth/quality factor.	Frequency, bandwidth/quality factor

Elevation	Adjust the band gain above the set frequency.	Frequency, gain
Low shelf	Adjust the band gain below the set frequency.	Frequency, gain
High pass	Remove frequency components below the set frequency	Frequency
Low pass	Remove the frequency components above the set frequency.	Frequency
Full pass	Do not change the spectrum, used to adjust the phase spectrum near the center frequency.	Frequency, bandwidth/quality factor
Butterworth high pass	Remove frequency components below the set frequency.	Frequency
Butterworth low pass	Remove the frequency components above the set frequency.	Frequency
Bessel high pass	Remove the frequency components above the set frequency.	Frequency
Bessel low pass	Remove the frequency components above the set frequency.	Frequency

"Frequency": For the three peak types of "peak", "notch" and "all-pass" filters, "frequency" is the center frequency, for "high", "low", "high pass", "low" "Pass", "Butterworth high-pass", "Butterworth low-pass", "Bessel high-pass" and "Bessel low-pass" eight band-pass type filters, "frequency" is the cut-off frequency.

"Gain": For the two peak type filters of "Peak" and "Notch", "Gain" is the gain of the center frequency. For the "high shelf" and "low shelf" filters of the two bandpass types, the "gain" is the band gain above or below the cutoff frequency.

"Bandwidth": For the two peak types of "peak" and "notch" filters, the bandwidth is the range of the filter's influence on the spectrum around the center frequency. The greater the bandwidth, the greater the range of influence.

"Quality factor": Can be converted with "bandwidth". The larger the quality factor, the smaller the bandwidth.

"Graph" :The graph is used to display the spectrogram and phase spectrogram of the filter. Press or pop up the "Gain", "Phase", "Segment Gain" and "Segment Phase" buttons to control whether to display the total spectrum, total phase spectrum, selected segment spectrum and selected segment phase spectrum, respectively.

The graph uses different colors to represent the control points of different segments. You can drag the control points on the graph to adjust the parameters of the

corresponding segment.

"Enable" button: Press to enable the algorithm, and not to enable the algorithm when it pops up.

"Reset" button: Reset all the parameters of the algorithm to the factory settings.

"Control point" button: Press the control points of all segments in the display curve graph, and it will not display when popped up.

"Gain" and "Phase" buttons: Press to display the total gain curve and total phase curve in the graph.

"Segment gain" and "Segment phase" buttons: Press to display the selected segment gain curve and the selected segment phase curve in the graph.

5.4 Compression

The compressor is used before mixing to prevent multiple input signals from being clipped and distorted due to excessive levels after mixing. The compressor performs level compression on input signals above a threshold. The interface is shown below.

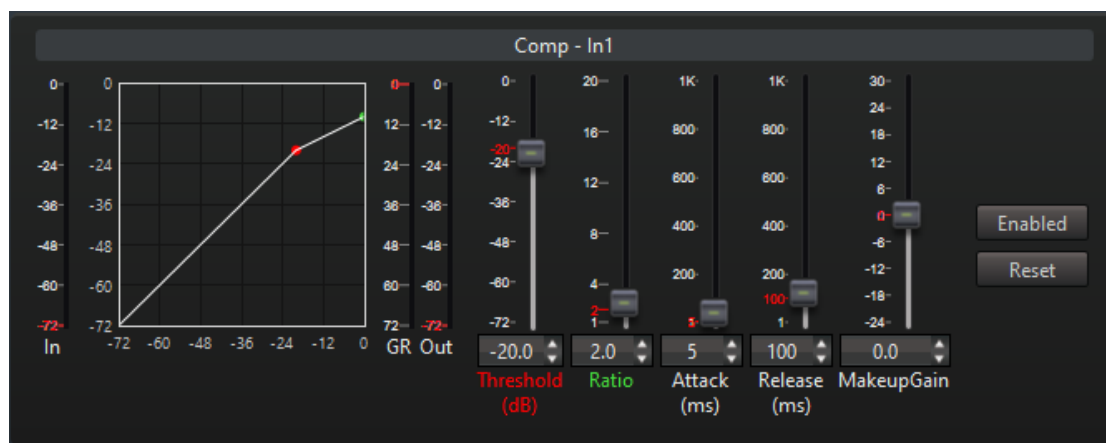

Figure 5-10 Compressor interface

"Input" level, "Compression" level, "Output" level

Real-time display algorithm input level, compression level and output level. Output level = input level-compression level.

Graph: The abscissa of the graph is the input level, and the ordinate is the output level. The graph shows the corresponding relationship between output level and input level. When the input level is greater than the threshold, the output level will be compressed in proportion. You can drag the control points on the graph to adjust the threshold and ratio.

"Threshold", "Ratio": As can be seen from the graph, when the input level is less than the threshold, the output is not compressed. When the input level is greater than the

threshold, the output will be compressed in proportion. The larger the ratio, the more compression.

"Startup time" and "Recovery time": The startup time is the time for the compressor to enter the compressed state, and the recovery time is the time for the compressor to recover from the compressed state to the normal state. The larger these two values are set, the less likely the sound will be distorted by the sudden gain, but the slower the algorithm's response. Normally, the recovery time should be greater than the startup time.

"Compensation gain": boost or attenuate the compressed signal.

"Enable": Press to enable the algorithm, and not to enable the algorithm when it pops up.

"Reset": Restore all the parameters of the algorithm to the factory settings.

5.5 Automatic gain

Automatic gain solves the problem of loud and small sounds caused by the speaker being far and near from the microphone. The automatic gain will directly output the signal lower than the threshold value, increase the signal greater than the threshold value and less than the target level, and attenuate the signal greater than the target level. Therefore, the input signal that is relatively small when away from the microphone is improved, and the input signal that is relatively large when close to the microphone is attenuated, so that the level of the output sound remains relatively stable. The interface of automatic gain is shown below.

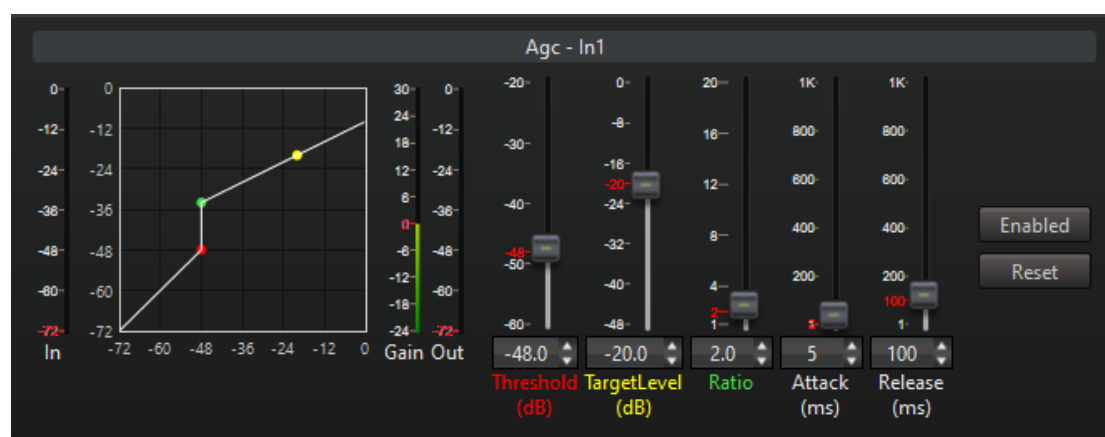

Figure 5-11 Automatic gain interface

"Input" level, "Gain" level, "Output" level: respectively display the input level, automatic gain level and output level in real time. Output level = input level + gain level. When the gain level is positive, it means to increase the input, and when the gain level is negative, it means to attenuate the input.

Graph: The abscissa of the graph is the input level, and the ordinate is the output level. The graph shows the corresponding relationship between output level and input level. You can drag the control points on the graph to adjust the "threshold", "target level" and "ratio".

"Threshold", "Target Level": By adjusting the "Threshold" and "Target Level", the microphone can have a relatively stable sound output. Normally, adjust the threshold when speaking away from the microphone, and when speaking near the microphone Adjust the target level.

"Ratio": Control the change range of output level. The larger the ratio, the smaller the change range of output level and the more stable the sound level. At the same time, the greater the distortion of the sound, the greater the emotional impact on the speaker. The ratio should generally not be set too large.

"Startup time", "Recovery time": The larger these two values are set, the less likely the sound will be distorted by the sudden gain change, but the slower the algorithm's response. Normally, the recovery time should be greater than the startup time.

"Enable": Press to enable the algorithm, and not to enable the algorithm when it pops up.

"Reset": Restore all the parameters of the algorithm to the factory settings.

5.6 Automatic mixing

This algorithm uses gain sharing automatic mixing (AutoMixerShare, AMS for short). Normally, multiple microphones are connected to the audio processor in a meeting, and usually only one person or a few people are talking at a time. If all microphone inputs are directly mixed to the output, the environmental noise collected by each microphone will also enter the output through the mixing, resulting in a lot of environmental noise in the output and poor sound quality. Gain sharing type automatic mixing dynamically adjusts the gain of each input port according to the volume and priority of each input port, so that the input port with higher volume and higher priority can obtain larger gains, The microphone input will be attenuated, thereby reducing noise output and improving the signal-to-noise ratio.

The interface of automatic mixing is shown below



Figure 5-12 Gain sharing automatic mixing interface

The right side of the interface is the overall parameters of automatic mixing, as shown in the figure below. From left to right are "slope", "response time", "gain", "output level", "enable" button and "reset" button.

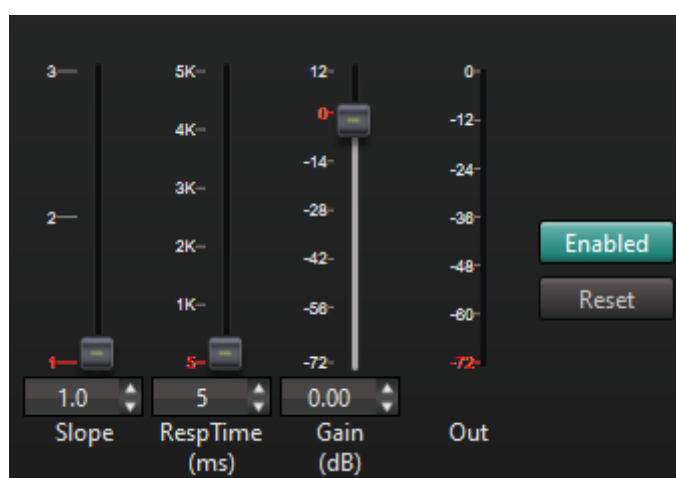

Figure 5-13 AMS overall parameters

"Slope": The greater the slope, the greater the difference in gain between different input ports due to the difference in input level. When the slope takes the minimum value of 1, the different input ports participating in automatic mixing will evenly distribute the total gain. The greater the slope, the greater the gain obtained by the speaking microphone, and the more the attenuation of the gain of the non-speaking microphone. The slope is usually set to 2. When the recorded environmental noise is large (for example, using an interface microphone), you can set the slope to be larger.

"Response time": the time from when you start speaking to when you get the allocated gain. The unit is milliseconds.

"Gain": Adjust the gain of the output after automatic mixing.

"Output" level: display the final output level of the algorithm in real time.

"Enable": Press to enable automatic mixing. If automatic mixing is not enabled, each input port participating in the mixing will be directly mixed to the output, and the effect at this time is equivalent to a normal mixer.

"Reset": Press this button, all the parameters of the algorithm will be restored to the

factory settings.

The interface of each input port is as shown in the figure below, from left to right are the "input" level, "gain", "automatic gain" level, "priority" and "mix" button.

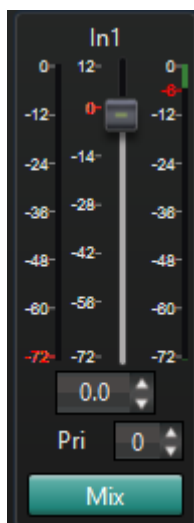

Figure 5-14 AMS single input port interface

"Input" level and "Auto gain" level: respectively display the input level of the input port and the obtained automatic gain in real time. Among them, the input level shows the level after "gain".

"Gain": Adjust the gain of the signal before the input port is mixed. The input port will automatically mix at the level adjusted by "Gain", and "Gain" will affect the "Auto Gain" assigned to the input port by the automatic mixing algorithm.

"Priority": The priority ranges from 0 to 10. The larger the value, the higher the priority. If the signals of the two input ports have the same level, the higher priority input port will get a higher automatic gain. At this time, the difference of the automatic gain obtained between the ports = priority difference * slope value. For example, if the slope is set to 2, the priority of port 1 is set to 6, and the priority of port 2 is set to 3, when these two ports receive the same level of signal, port 1 will get higher than port 2 $(6 - 3) * 2 = 6\text{dB}$ automatic gain. It is recommended not to set the priority difference between ports to be too large. Otherwise, the unspeaked high-priority microphones may obtain higher gain, while the talked low-priority microphones may obtain too low gain.

"Mix": Press this button, the input port will be mixed to the output, when it is popped up, it will not be mixed to the output.

5.7 Feedback/Echo cancellation

In local sound reinforcement, the sound picked up by the microphone will be amplified and played out from the speaker, and the sound will be picked up by the microphone again, and then amplified and played out from the speaker. After the sound is amplified by multiple feedbacks, howling may occur.

In a remote conference, after the far-end voice is played through the local speaker, it will be picked up by the local microphone and sent back to the far-end, causing the far-end participants to hear the echo of their speech.

Feedback/echo cancellation can simultaneously eliminate local howling and far-end echo, and maintain the original sound quality. The algorithm has a built-in noise suppression function, which can eliminate steady-state environmental noise and improve the clarity of audio signals. The maximum trailing time supported by this algorithm is 256 milliseconds.

The interface of feedback/echo cancellation is shown below.

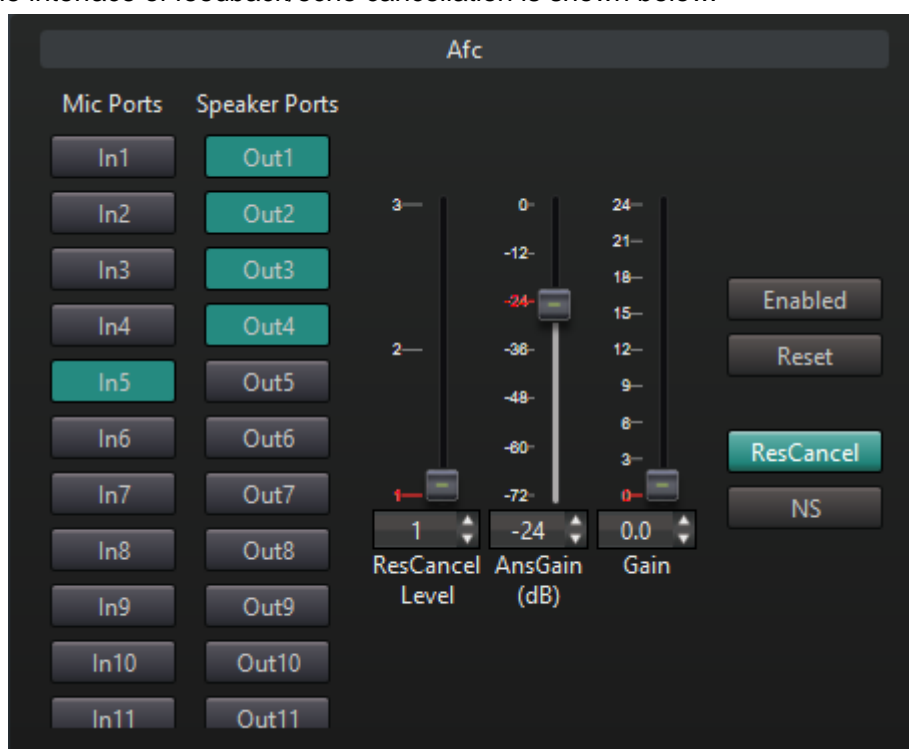

Figure 5-15 Feedback/Echo Cancellation

"Microphone port": The microphone port lists all the mixing buttons of the input ports. It is necessary to press the mixing buttons of all the input ports connected to the microphone to mix their input signals to the feedback/echo cancellation input to remove the acoustic feedback from the sound picked up by the microphone to achieve howling and echo cancellation.

"Speaker port": All the output ports are listed in the speaker port. It is necessary to press the mixing button of all the output ports connected to the speaker to mix their output signals to the reference signal input terminal of feedback/echo cancellation, so that Provides a reference signal for the feedback/echo cancellation algorithm.

Residual echo cancellation level: The values are 1, 2, and 3. The larger the value, the more residual echo cancellation. At the same time, the greater the distortion of the output sound, the lower the output volume.

"Noise reduction gain": Noise reduction gain is the amount of noise attenuation. The value ranges from 0 to -72dB. The larger the value, the more the noise is attenuated, and the smaller the noise in the output sound. At the same time, the greater the distortion of the output sound.

"Gain": The gain of the output signal. This gain is only effective when feedback cancellation is enabled.

Without enabling feedback cancellation first, by reasonably adjusting other gains on the sound channel, the system is in a state of near howling. Then enable feedback cancellation and gradually increase the gain in the "Gain" input box until the system reaches the optimal. The "gain" set last is the sound transmission gain that the feedback cancellation algorithm can increase. The sound transmission gain that can be improved after starting feedback cancellation is set here, which can easily compare the output effect when the feedback cancellation algorithm is enabled and not.

"Enable" button: Press to enable the algorithm, and not to enable the algorithm when it pops up.

"Reset" button: Press this button to restore all the parameters of the algorithm to the factory settings. The mixing buttons in the microphone port and speaker port will remain unchanged.

"Residual Echo Cancellation": Press to enable the Residual Echo Cancellation function.

"Noise reduction": Press to enable the noise reduction function, and not to activate when it pops up.

5.8 Noise suppression

Noise suppression can reduce or remove stationary noise in the input signal. This includes ambient noise recorded by the microphone or noise introduced on the line. Noise suppression is the same as the noise suppression function in feedback/echo cancellation, but it can be used independently for scenes such as line input or recording output noise

reduction. The interface of noise suppression is shown below.

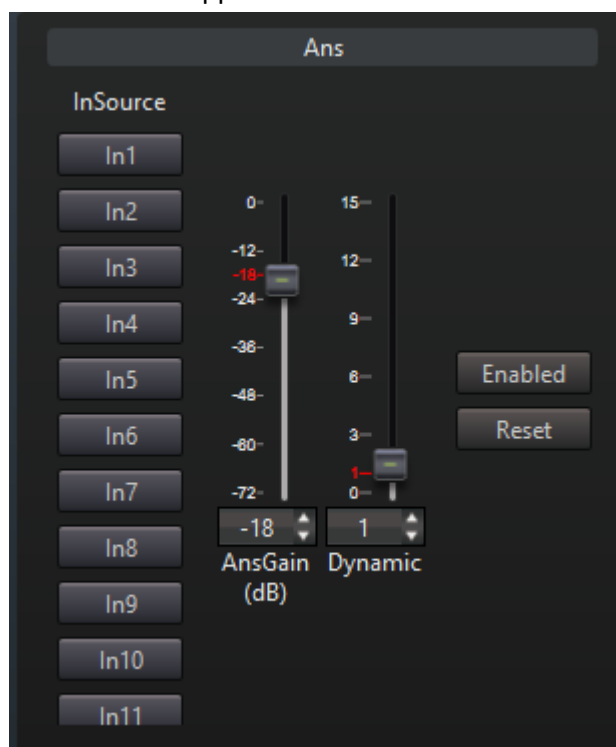

Figure 5-16 Noise suppression

The input source lists the mixing buttons of all input ports. Press the mix button of the input port that requires noise suppression to mix them into the noise suppression input.

"Noise reduction gain": Noise reduction gain is the amount of noise attenuation. The value ranges from 0 to -72dB. The larger the value, the more the noise is attenuated, and the smaller the noise in the output sound. At the same time, the greater the distortion of the output sound.

"Dynamic": Usually set to 1.

"Enable" button: Press to enable the algorithm, and the algorithm will not be enabled when it pops up.

"Reset" button: Press this button to restore all the parameters of the algorithm to the factory settings. The mixing buttons in the microphone port and speaker port will remain unchanged.

5.9 Mixer

The mixer mixes the sound from the input port to the output port. The interface of the mixer is shown below. The input ports are arranged in columns and the output ports are arranged in rows. At the intersection of rows and columns are mixing buttons arranged into a mixing matrix. Press the mixing button "A->B" at the intersection of input port A and output port B to mix input port A into output port B. Multiple input ports can be mixed into

the same output port at the same time.

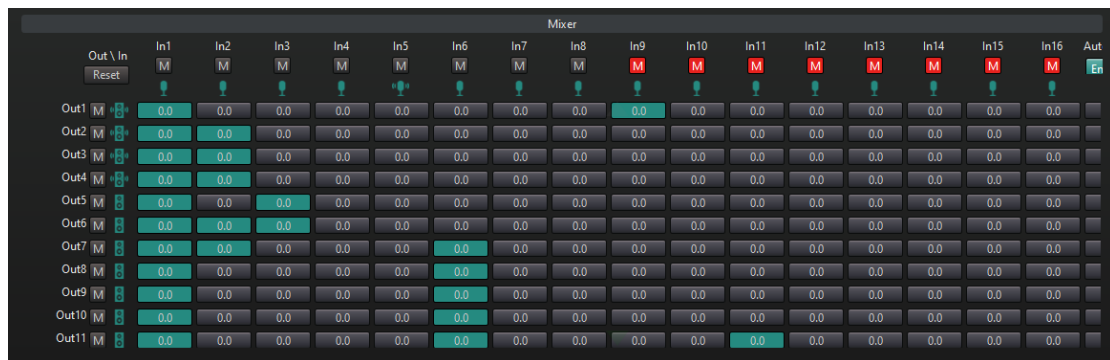

Figure 5-17 Mixer

Hovering the mouse over the mixing button will prompt the name of the mixing button. The name of the mixing button takes the form of "input port -> output port".

The number displayed on the mixing button is the mixing gain from its input port to its output port. Click the right mouse button on the mixing button to adjust the mixing gain in the right-click menu. The value range is -72dB~12dB.

Click the input (or output) port name in the mixer to switch the current port in the input (or output) port list. Click on the algorithm name to enter the control interface of the algorithm.

The mixer also displays a "port mute" button and algorithm enable button; you can easily view and change the port mute state and algorithm enable state.

In addition to external input ports, the mixer also lists the outputs of automatic mixing, feedback/echo cancellation, and noise suppression as its input ports, and the input of these algorithms itself is also mixed from multiple input ports. When these algorithms are mixed into an output port, the external input ports mixed into their input ports are indirectly mixed into the output ports.

The mixing configuration in Figure 5-18 is shown in the figure below.

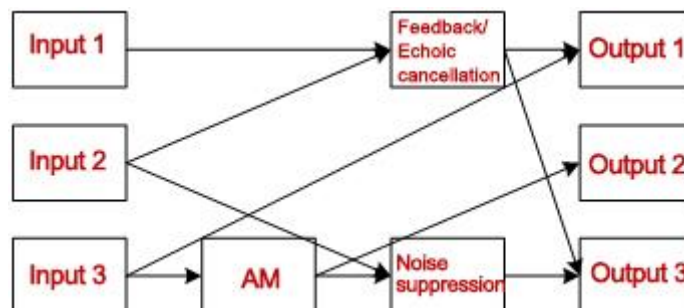

Figure 5-18 The mixing relationship in Figure 5-18

described as follows.

"Input 3" mixes to the "Automix" input;

"Input 1" and "Input 2" are mixed to the input of "Feedback/Echo Cancellation";

The output of "Input 2" and "Auto Mix" is mixed to the input of "Noise Suppression";

The output of "Feedback/Echo Cancellation" and "Input 3" are mixed to "Output 1";

The output of "Auto Mix" is mixed to "Output 2";

The output of "feedback/echo cancellation" and the output of "noise suppression" are mixed to "output 3";

In Figure 5-18, when the mixing button of "Feedback/Echo Cancellation -> Output 1" is pressed, the button is displayed in red corresponding to the "Feedback/Echo Cancellation" output, due to the input of "Feedback/Echo Cancellation" The port is mixed with "input 1" and "input 2", so the mixing buttons of "input 1->output 1" and "input 2->output 1" are also automatically pressed and displayed as "feedback/echo cancellation" ->The output button of the output 1 is the same red, which means that "input 1" and "output 2" are indirectly mixed into "output 1" via "feedback/echo cancellation". In contrast, "input 3" was also mixed to "output 1", but the mix did not go through other modules, so the "input 3->output 1" mix button is displayed in green, indicating that it is an independent mix.

Similarly, "Input 3" was indirectly mixed to "Output 2" via "Auto Mix", and the "Input 3->Output 2" mix button was automatically pressed, showing it as "Auto Mix-> Output 2" "The mixing button is the same yellow.

"Automatic mixing" and "feedback/echo cancellation" and "noise suppression" are tandem algorithms. In Figure 5-19, the "input 3" is mixed to the "automix" input, the "automix" output is mixed to the "noise suppression" input, and the "noise suppression" output is mixed again to "Output 3". In this way, "automix" is indirectly mixed to "output 3" via "noise suppression", and "input 3" is also indirectly mixed to "output 3" via "automix" and "noise suppression". Therefore, the "Auto Mix->Output 3" and "Input 3->Output 3" mixing buttons are automatically pressed and displayed in the same blue color as the "Noise Suppression->Output 3" mixing button.

"Feedback/Echo Cancellation" and "Noise Suppression" are parallel algorithms, both of which are mixed to "Output 3". At this time, "input 2" is simultaneously mixed into "output 3" via "feedback/echo cancellation" and "noise suppression" in parallel. In Figure 5-18, the "Input 2->Output 3" mixing button is displayed as the same two buttons as the "Feedback/Echo Cancellation->Output 3" mixing button and the "Noise Suppression->Output 3" mixing button. Colors of various colors.

At this time, the sound from "input 2" to "output 3" via "noise suppression" did not

undergo "feedback/echo cancellation", and the sound to "output 3" via "feedback/echo cancellation" did not undergo "noise suppression" ", causing both "feedback/echo cancellation" and "noise suppression" to be useless, so this is a wrong configuration.

When more than two colors appear on the mixing button at the same time, it means that the input of the mixing button is mixed into the output of the mixing button in parallel, which will cause the algorithm on its parallel path to become invalid and the configuration needs to be changed.

In this example, as long as the "Input 2->Output 3" mixing button is popped up, the "Input 2->Feedback/Echo Cancellation" and "Input 2->Noise Suppression" mixing can be removed at the same time.

5.10 Frequency division

The frequency divider performs high-pass, low-pass or band-pass processing on the output signal, and removes unnecessary frequency components in the output signal according to the requirements of the actual application. When the frequency divider is applied to a frequency dividing speaker, the frequency divider on multiple output ports can be combined to divide the frequency of the same signal, so that different frequency bands of the same signal are output to different frequency dividing speakers. The interface of the frequency divider is shown below.

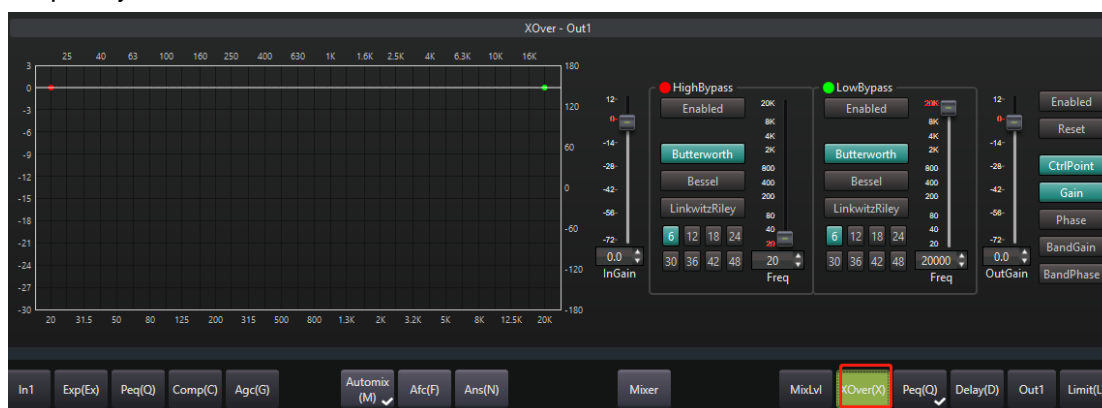

Figure 5-19 Frequency divider

"Input Gain": Increase or attenuate the input signal.

"Output gain": Increase or attenuate the output signal.

The frequency divider is composed of a high-pass filter and a low-pass filter. The interface of the high-pass filter is shown in the figure below. The interface of the low-pass filter is similar.

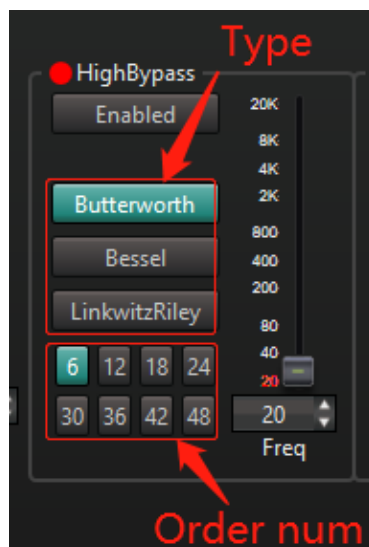

Figure 5-20 High-pass filter interface.

"Enable": Press to enable the high-pass filter, but not to enable it when it pops up.

Type, order: There are three types of filters: Butterworth, Bessel, LinkwitzRiley; when the order is the same, the passband of Butterworth filter is flatter than the Bessel filter, and the stopband the decline is faster; the stop band of the Bessel filter has the best linear phase. When the filter types are the same, the larger the order, the faster the stopband decreases.

Frequency: Set the cut-off frequency of the high-pass filter. The value range is 20~20K.

The overall parameters of the algorithm are described below.

"Enable": Press to enable the algorithm, and it will not be activated when it pops up.

"Reset": Restore all the parameters of the algorithm to the factory settings.

"Control point": Press the control point in the display graph.

"Gain", "Phase": Press to display the total gain and total phase curves in the graph.

"Segment gain", "Segment phase": Press to display the gain curve of the selected segment and the phase curve of the selected segment in the graph.

5.11 Delay

The delayer delays the output signal. Different delays can be set for different output ports according to actual application requirements to ensure that each output port can form a correct sound image in the same sound field. The interface of the delayer is shown below.

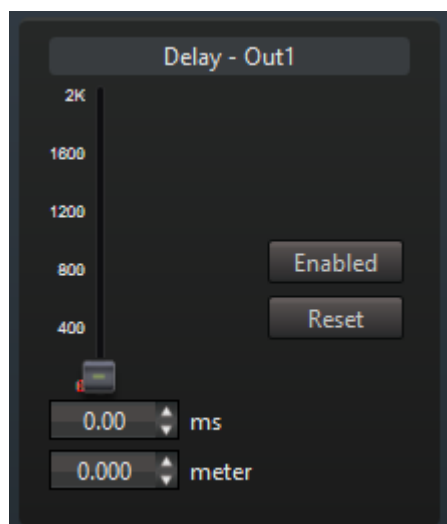

Figure 5-21 Delay

The delay can be set according to time or distance. The value range of the delay is 0.01 milliseconds to 2000 milliseconds (0.003 meters to 680 meters).

"Enable": Press to enable the algorithm, and the algorithm will not be enabled when it pops up.

"Reset": Restore all the parameters of the algorithm to the factory settings.

5.12 Output

Clicking on the output port name in the algorithm list will open the output setting interface, as shown in the figure below.

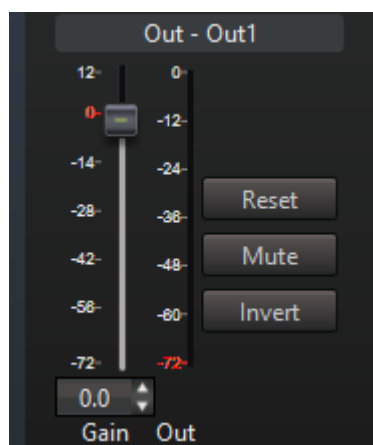

Figure 5-22 Output settings

"Gain": Boost or attenuate the output signal.

"Output" level: The output level after gain display in real time.

"Reset": Restore all parameters of the module to factory settings.

"Mute": Press to enter "Port Mute", pop up to exit "Port Mute".

"Invert": Invert the output signal. The "reverse phase" function can increase or decrease the mutual cancellation between two homologous signals as needed.

5.13 Limit

The limiter can prevent the sound from "breaking" due to peak clipping and protect the speaker. The common limiter is usually a special case of a compressor, that is, a compressor with a small start-up time and a large slope. This limiter cannot completely avoid peak clipping. The limiter in this device has the advantages of no start time and absolute limit, which can better avoid the occurrence of peak clipping.

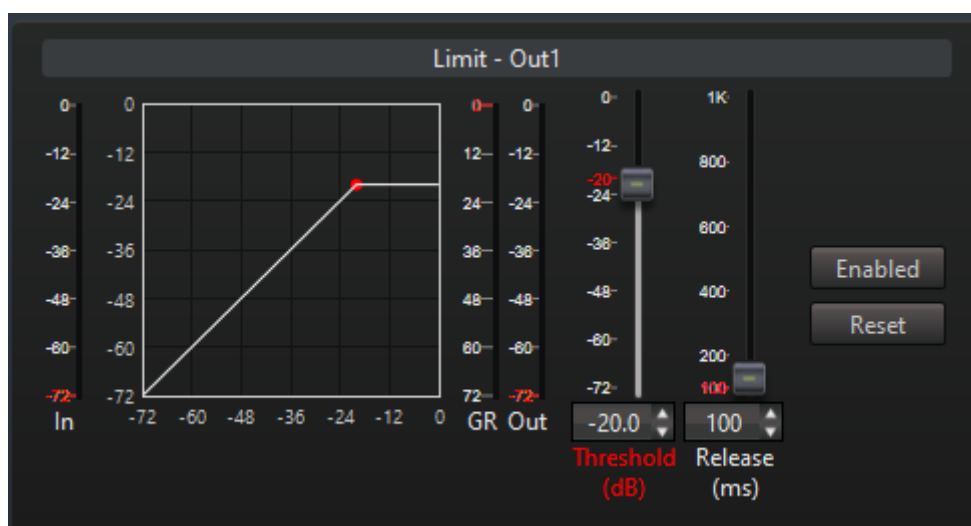

Figure 5-23 Limiter

"Input" level, "Compression" level, "Output" level: Real-time display of input level, compression level and output level. Output level = input level-compression level.

Graph: The abscissa of the graph is the input level, and the ordinate is the output level. The graph shows the corresponding relationship between output level and input level. When the input level is greater than the threshold, the output level will be clipped. You can drag the control points on the graph to adjust the threshold.

"Threshold", "Recovery Time": The smaller the threshold, the less likely peak clipping will occur, but the greater the sound distortion. Under normal circumstances, the threshold should be set larger to avoid sound distortion. When the threshold is set lower, it is recommended to increase the recovery time.

"Enable": Press to enable the algorithm, and it will not be activated when it pops up.

"Reset": Restore all the parameters of the algorithm to the factory settings.

6. FAQ

Q: For the first time to use our audio processor, what configuration is required?

The first time we use our audio processor, there are mainly the following steps:

(1) Please read the instructions carefully, pay special attention to safety matters, safety first.

(2) Connect the power cord and network cable according to the instructions on the rear panel of the device; connect the input device (microphone, line input, etc.) to the INPUT port of the device, and the output device (amplifier, etc.) to the OUTPUT port. And power the equipment.

(3) The factory default IP address of the device is "192.168.20.20", add the device to the device list in the interface program, and set its IP address to the device's IP address. You can also obtain the IP address of the device through "Search" and add it to the device list. Set the correct login user name and login password. The default values of user name and password are "admin" and "admin" at the factory.

(4) You need to add an IP address that is the same as the network segment of the device's IP address "192.168.20.*" to the PC to log in to the device normally. For example, the added IP address is: "192.168.20.15", and the subnet mask is "255.255.255.0". The addition process is as follows (take Windows 7 Chinese version as an example): Start->Control Panel->Network and Sharing Center->Local Area Connection->Properties->Internet Protocol 4 (TCP/IPv4)->Use the following IP address. If you do not need to keep the original IP address of the PC, you can fill in the IP address and subnet mask to be added here. Otherwise, fill in the original IP address, subnet mask and default gateway of the PC here, then click "Advanced -> IP address -> Add" in this dialog box, and enter the IP to be added in the pop-up dialog Address and subnet mask. Click "Add->OK->OK".

(5) Select the device added in (3) on the interface and click "Login". If the device login status is displayed as "Logged in", it indicates that the device has been logged in correctly.

(6) According to the type of input microphone, decide whether to turn on the phantom power and adjust the input sensitivity. When the input port is connected to the line input, the phantom power should not be turned on, otherwise the input device may be damaged. If the sensitivity is set too high, the input signal may be clipped and severely distorted.

Q: Why is there no sound output?

(1) Check whether the input port and output port are properly connected to the

device.

(2) Check whether the mute buttons of the input port and output port are muted.

(3) Check whether the levels of the input port and output port are beating, and check whether there is sound from the input source.

(4) The signal of the signal generator built in the device can be used for testing to check whether there is sound in the output.

(5) Click the "Expand Channel" button on the "Audio Channel" tab to check whether the output level of each algorithm is jittery. For the algorithm without an output level, you can pop up its enable button to see if there is an output level.

(6) Check the parameter setting without output level algorithm, for example, check whether the threshold of the noise gate is too large, and whether the values of the compressor and limiter are too small.

(7) Check whether the output amplifier is working normally.

Q: Why is the output sound quality not good, sometimes there is a rustling sound?

(1) When the signal is clipped, the sound will be broken. Check the input and output levels. If the level is too large, it may cause peak clipping.

(2) Click the "Expand Channel" button on the "Audio Channel" tab to check whether the output level of each algorithm is too large.

(3) Check whether the parameter configuration of each algorithm is reasonable, such as EQ parameters and frequency divider parameters. You can pop up the algorithm's enable button to compare the effect of the output sound.

(4) Check whether the signal of the signal generator is mixed.

(5) When performing local amplification on the input signal of the microphone, howling may occur when the gain is too large. Please reduce the sound transmission gain. Turning on feedback cancellation can increase the sound transmission gain to a certain extent and improve the sound quality.

Any problems with the device can be reported to us in order to analyze and solve the problems, or improve in future versions.